

### Principle

This coupling eliminates misalignment with the simplicity and safety of a rubber tyre

### Advantages

- Maintenance-free: no routine maintenance or lubrication required
- Designed for quick and easy installation and replacement of components without moving the hubs or realigning the driver or driven equipment, reducing downtime.
- High misalignment capabilities: compensates for extremely large angular, axial and radial misalignments
- Vibration dampening and shock absorption: due to its quick smoothing qualities, provides damping properties to the torsional vibration induced in the system by cyclic variation of the twisting moment and shocks induced by the fast load variation, protecting the entire system

### Application

- For difficult alignments characteristics
- Ideal for applications with vibration and thermal expansion
- With high response to torque peaks and great shocks



**NEW!**

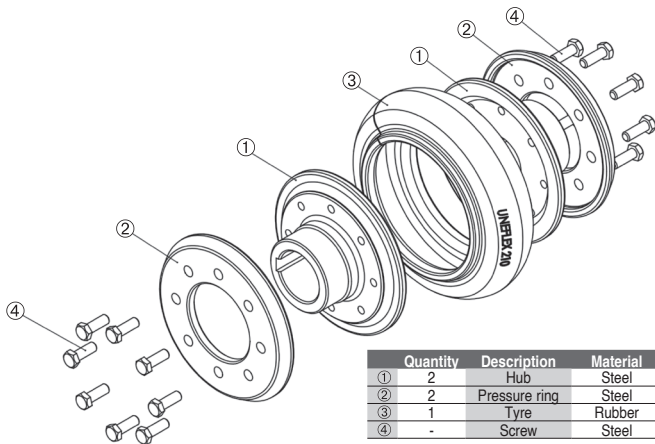

	Quantity	Description	Material
①	2	Hub	Steel
②	2	Pressure ring	Steel
③	1	Tyre	Rubber
④	-	Screw	Steel

- **Rubber tyre coupling**
- Eliminates misalignment with the simplicity and safety of a rubber tyre

### Material

Hubs: steel

Tread: fabric-reinforced natural rubber

- Operating temperature: -20°C to +80°C

### Info.

- Sold pre-bored, to be bored by yourself



**NEW!**

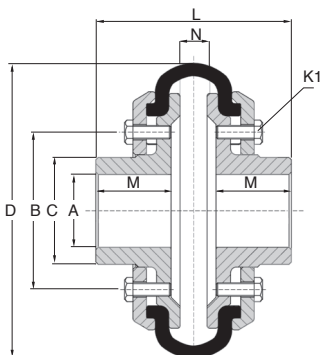

### DISCOUNTS

Qty	1+	2+	4+
Disc. List	-5%	-5%	On request

Part numbers	Nominal torque (Nm)	Max torque (Nm)	Max speed (RPM)	Misalignment			Relative damping	Moment of inertia (kg.m <sup>2</sup> )	Tightening torque screw K1 (Nm)
				Axial max (mm)	Radial max (mm)	Angular max (°)			
UFX2-203R	50	150	5000	1,00	0,75	2	1,2	0,0019	4
UFX6-206R	100	300	5000	1,50	1,00	2	1,2	0,0043	6
UFX16-210R	200	600	4000	2,00	1,30	2	1,2	0,124	15
UFX40-214R	400	1200	4000	2,50	1,60	2	1,2	0,0347	20
UFX63-218R	800	2400	3000	3,00	2,00	2	1,2	0,118	25

Part numbers full coupling	ØD	ØB	ØC	ØA pilot bore	ØA max	L	M	N	K1	Mass (kg)	Price each
UFX2-203R	104	54	40	10	28	70	30	8	6xM6	1,15	249,80 €
UFX6-206R	136	68	55	10	38	110	45	8	8xM6	2,50	264,92 €
UFX16-210R	178	88	70	15	48	130	50	19	8xM8	5,40	354,72 €
UFX40-214R	210	116	92	15	65	160	65	20	12xM8	9,50	460,14 €
UFX63-218R	263	140	107	25	75	190	75	24	8xM12	17,50	805,56 €

Dimensions in mm

## UFX

## Mounting and spare tyres

- Tyre for UNEFLEX coupling
- Replacement of the tyre without moving the machines
- Material  
Fabric-reinforced natural rubber (R arrangement)

### Assembly

To assemble the Uneflex coupling, mount the hubs ① together with the pressure rings ② on the shaft ends and align the system parts. The distance between the hubs "N" must be the one indicated on the data sheet.

The tyre ③ is mounted on the coupling hubs, fitted to provide the smallest possible gap between its faces. For large couplings, before tightening the pressure rings, it is recommended to use clamping bands to fit the tyre.

The tyre is secured with the prescribed wrench torque by means of the pressure ring and the screws ④

The fixation must be always carried out tightening two diametrically opposite screws in cyclic order, retightening the bolts after the first tightening as the rubber settles.

For replacing the tyre, only loosen the screws, until the tyre can be withdrawn.

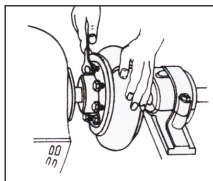
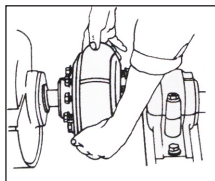
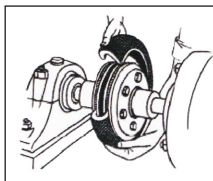
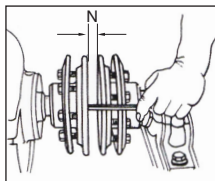

### DISCOUNTS

Qty	1+	2+	4+
Disc.	List	-5%	On request

Part numbers tyre only	For coupling UFX	Price each
TYRE-203R	UFX2-203R	53,63 €
TYRE-206R	UFX6-206R	62,49 €
TYRE-210R	UFX16-210R	70,01 €
TYRE-214R	UFX40-214R	87,68 €
TYRE-218R	UFX63-218R	115,28 €

Dimensions in mm

### Selection procedure

In order to design a coupling for a system, the following equation is used to determine the rated torque  $T_N$  of the application:

$$T_N \text{ [Nm]} = \frac{P_{\text{motor}} \text{ [kW]}}{n \text{ [rpm]}} \cdot 9549 \cdot S$$

$T_N$  = Application rated torque [Nm]

$n$  = Rated speed of engine [tr/min]

$T_{\text{MAX}}$  = Application peak torque [Nm]

$S$  = Service factor

$P$  = Rated power of drive [kW]

The permissible rated torque  $T_{KN}$  of the coupling has to correspond at least to the rated torque  $T_N$  of the application.

The permissible maximum torque  $T_{Kmax}$  of the coupling has to correspond at least to the peak torque  $T_{MAX}$  of the application.

Check that the coupling can accommodate required bores and rated speed.

### Service factor

The service factor  $S$  is obtained according to the following table, from the driver type of motor and the driven machine group in which the coupling will be installed

Driver motor type	Driven machine group No.				
	I	II	III	IV	V
Electric motor	1,0	1,5	2,0	2,5	3,0
Steam turbine					
Gas machine	1,5	2,0	2,5	3,0	3,2
Hydraulic turbine					
Diesel 4-6 cylinders					
Diesel 2-3 cylinders	2,2	2,5	2,8	3,2	3,5
4 Stroke motor					
Diesel 1-2 cylinders	2,6	2,8	3,0	3,5	4,0

Group I: Continual load machines: such as generators, small fans

Group II: Variable load machines: such as small elevators, generators, winches

Group III: Normal size to heavy machinery: such as mechanical mixers, cutters, brick presses

Group IV: Heavy machinery: such as dredge control mechanism, sand and paper grinders, compound mills

Group V: Heavy machinery of variable power consumption such as large drilling installations, roller tables for mills

### Torque and misalignment



Axial



Angular



Radial



Damping

### Storage and maintenance

In order to ensure a long-life cycle of the rubber element, it is fundamental to store the tyre protecting it against ozone, light (specially ultra violet rays), heat and oxygen, in a room with a relative humidity of less than 65% with a storage temperature range between +10°C and +25°C and without storing in the same room disinfectants, acids, chemicals and other similar substances that may cause a depreciation of the tyres.

Further details of the guideline for rubber product storage can be found in the standard ISO 2230. The coupling design allows a perfect inspection of the transmission tyre without dismantling the coupling, so a periodical visual inspection is recommended.

## Altri prodotti...



GE\_ES\_2RS

Snodo sferico,  
acciaio/acciaio e  
guarnizioni di tenuta



MET

Cuscinetto cilindrico ,  
Self-lubricating  
sintered bronze

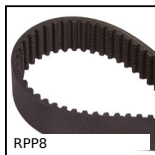

RPP8

Cinghia di  
trasmissione RPP,  
RPP8



ZHG6

Ingranaggio dritto in  
plastica, Plastica  
lavorata (delrin)



CDC

Molla di compressione  
conica, Conica



G0

Ingranaggio dritto  
acciaio, Acciaio  
20NCD2

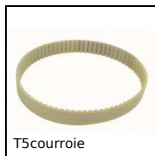

T5courroie

Cinghia di  
posizionamento T, T5  
Poliuretano armatura  
in acciaio



SLBW

Pistoncino a molla, Da  
saldare - Acciaio



PGM52-M4

Maniglia a ponte,  
Ottone



G0

Ingranaggio dritto  
acciaio, Acciaio  
20NCD2



UGPC

Unità di guida per  
cilindrico, Cuscinetto  
corto



M0

Coppia ruota e vite  
senza fine , Acciaio  
non temprato

## Prodotti correlati



UFX

Giunto elastico  
Uneflex®, economica