

Adjustable furniture foot

For square tube

PTCR

Furniture foot with simple height adjustment

- For square tubes 20x20mm to 50x50mm
- Turn to adjust height
- Working T° -30°C to +80°C
- Material:

Thermoplastic PA12 black

Advantages

- Easy height adjustment
- Easy to install in the tube by pressure mounting

Info

- Not sold individually, please contact us for details

NEW!



Example of use

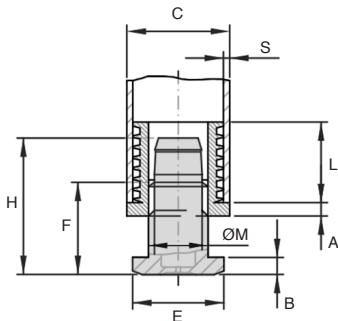
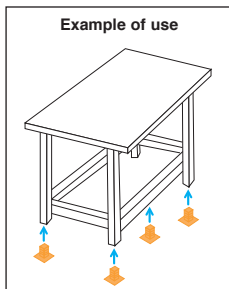

DISCOUNT

Qty	1+	60+	100+	200+
Disc.	List	-5%	-10%	On request

Part number	C	E	A	B	ØM	F	L	H	S	Stock*	Price each 1 à 59
PTCR20-M10	20	20	5	4	M10	24	16,7	-	1,5 - 2	-	1,88 €
PTCR25-M16	25	24	5	5	M16	22	20	34,5	1,5 - 2	-	2,08 €
PTCR30-M22	30	28	5	5	M22	20	19,5	45,5	1,5 - 2	-	1,96 €
PTCR35-M22	35	28	5	5	M22	21,5	29,3	34,5	1,5 - 2	-	3,04 €
PTCR40-M22	40	28	5	5	M22	21,5	29,3	34,5	1,5 - 2	-	3,48 €
PTCR50-M30	50	41	5	5	M30	28	29,3	45,5	1,5 - 2	-	4,72 €

*Depending on availability - Dimensions in mm

Stainless steel telescopic furniture foot

With threaded stud

PTMR

Furniture foot with simple height adjustment

- Turn to adjust height
- Materials:
Stainless steel foot 304
Glass fibre reinforced nylon internal thread
Anti-slip pad in black PVC

Advantages

- Easy height adjustment
- When washing, the water flows over the outer part of the foot



NEW!

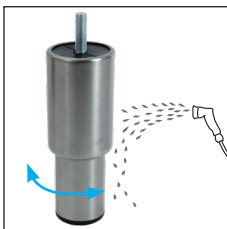

Example of use: metal cabinet

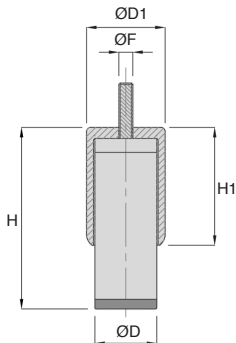
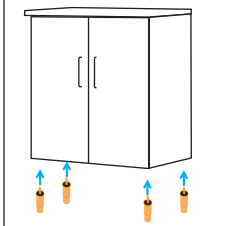

DISCOUNT

Qty	1+	6+	10+	15+	20+
Disc.	List	-5%	-10%	-15%	On request

Part number	ØD	ØD1	H	H1	ØF	Static load (N)	Stock*	Price each 1 à 5
PTMR30-40-M10	30	40	80/110	67	M10x15	3000	-	21,39 €
PTMR44-56-M10	44,5	56,5	130/180	85	M10x30	5000	-	26,58 €
PTMR56-64-M10	56,5	64	130/180	85	M10x30	8000	-	29,25 €

*Depending on availability - Dimensions in mm

Stainless steel telescopic furniture foot

With square plate

PTMC

Furniture foot with simple height adjustment

- Turn to adjust height
- Materials:
 - Stainless steel foot 304
 - Glass fibre reinforced nylon internal thread
 - Anti-slip pad in black PVC

Advantages

- Easy height adjustment
- When washing, the water flows over the outer part of the foot

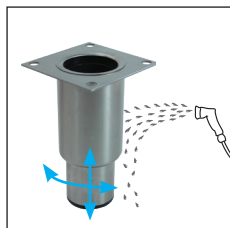

Example of use:
metal cabinet

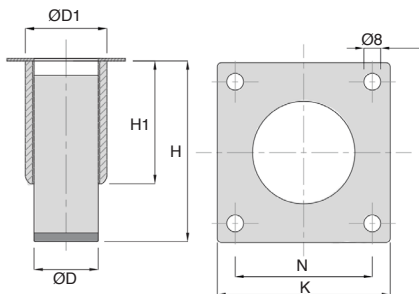
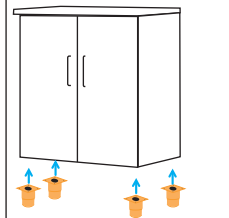

DISCOUNT

Qty	1+	6+	10+	15+	20+
Disc.	List -5%	-10%	-15%	-	On request

Part number	ØD	ØD1	H	H1	K	N	Static load (N)	Stock*	Price each 1 to 5
PTMC44-56-82	44,5	56,5	130/180	85	82	65	5000	-	31,23 €
PTMC56-64-82	56,6	64	130/180	85	82	65	8000	-	33,81 €

*Depending on availability - Dimensions in mm

Altri prodotti...



AT5M AT10M

Cinghia aperta al metro tipo AT, AT10 Poliuretano armatura in acciaio



BC2

Panamech, Multi-Beam, Alluminio - con ganascia di serraggio



COA-COG

Staffa di montaggio per molla a gas, Staffa di montaggio piana per f...



DB

Ingranaggio conico - Acciaio 60C40, 2:1



AC144

Piastrina di riscontro piatta per chiusura, 22mm



PAT123

Piede snodato con base lamiera Ø123, Ø 123



HTD8M_30

Puleggia dentata di trasmissione tipo HTD, HTD8 Ghisa



PRES4HR

Pressa manuale da banco, Pressione fino a 600kg



NDS20

Connettore di serraggio, Parallela



PSG055

Ingranaggio dritto di precisione, Inox 303



RCX-6

Rondella sferica - DIN6319, concava



PCS625S

Pignone a catena - Inox, 15.875mm (DIN 08B-1)

Prodotti correlati



PTCR

Adjustable furniture foot, square tube



PTMR

Telescopic furniture foot, threaded stud