

SteSta Articulated foot with solid base foot Ø40

Accepts loads up to 3000N

PTA40
PTA40ss

- **Articulated foot**
- Up to +/- 10° from vertical
- Materials:

Steel version:

Base: Galvanised sheet steel C40
Shaft: Galvanised steel (nut not supplied)
Sole: Vulcanised NBR rubber,
hardness 80° Shore

Stainless steel version:

Base: Sheet stainless
steel 304
Shaft: Stainless steel 304
(nut not supplied)
Sole: Vulcanised NBR
rubber, hardness 80°
Shore

Stainless steel
version,
sanded finish

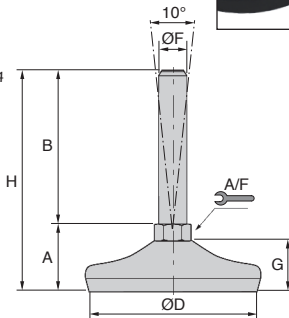

Advantages

- Excellent Price-Quality ratio

DISCOUNTS

Qty	1+	15+	20+	25+	40+
Disc.	List	-5%	-10%	-15%	On request

Part number		ØD	ØF	B	A	A/F	G	H	Static load (N)	Stock* Bright	Price each 1 to 14
bright	sanded finish										
Steel foot											
PTA40-8-25	-	40	M8	25	26	6	15	51	3000	-	10,80 €
PTA40-8-50	-	40	M8	50	26	6	15	76	3000	-	11,22 €
PTA40-8-75	-	40	M8	75	26	6	15	101	3000	-	11,67 €
PTA40-10-25	-	40	M10	25	26	8	15	51	3000	-	11,22 €
PTA40-10-50	-	40	M10	50	26	8	15	76	3000	-	11,67 €
PTA40-10-75	-	40	M10	75	26	8	15	101	3000	-	12,09 €
PTA40-10-100	-	40	M10	100	26	8	15	126	3000	-	12,39 €
PTA40-10-125	-	40	M10	125	26	8	15	152	3000	-	12,54 €
Stainless steel foot											
PTA40-8-25/SS	PTA40-8-25/SS/SB	40	M8	25	26	6	15	51	3000	-	13,14 €
PTA40-8-50/SS	PTA40-8-50/SS/SB	40	M8	50	26	6	15	76	3000	-	13,53 €
PTA40-8-75/SS	PTA40-8-75/SS/SB	40	M8	75	26	6	15	101	3000	-	14,01 €
PTA40-10-25/SS	PTA40-10-25/SS/SB	40	M10	25	26	8	15	51	3000	-	14,31 €
PTA40-10-50/SS	PTA40-10-50/SS/SB	40	M10	50	26	8	15	76	3000	-	14,76 €
PTA40-10-75/SS	PTA40-10-75/SS/SB	40	M10	75	26	8	15	101	3000	-	15,21 €
PTA40-10-100/SS	PTA40-10-100/SS/SB	40	M10	100	26	8	15	126	3000	-	16,08 €
PTA40-10-125/SS	PTA40-10-125/SS/SB	40	M10	125	26	8	15	151	3000	-	16,71 €

All dimensions in mm

Articulated fixable foot, pressed bolt-down base Ø80 **SteSta**

PTAF80 PAMF80

Accepts loads up to 10.000N

- **Tilting foot**
- Tilt up to +/- 5° from vertical
- With non-slip sole
- Materials:

Steel version:

Base : Galvanised sheet steel C40

Spindle: Galvanised steel (nut not supplied)

Sole: Vulcanised NBR rubber, hardness 80° Shore

Stainless steel version:

Base: Stainless steel sheet 304

Spindle: Stainless steel 304 (nut not supplied)

Sole: Vulcanised NBR rubber, 80° Shore

Stainless steel version, sanded finish



Large hole allows use of a rawlplug

Large spacing allows use of a hammer drill

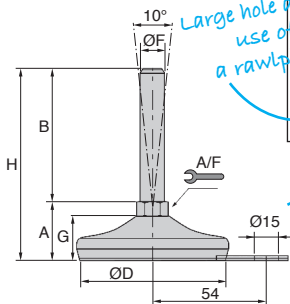

Advantages

- Easy to secure due to large distance between shaft and mounting hole

Option

- Other shaft dimensions are available on request

DISCOUNTS

Qty	1+	6+	10+	15+	20+
Disc.	List	-5%	-10%	-15%	On request

Références		Thread		ØD	B	A	A/F	G	H	Static load(N)	Price each	
Bright	Sanded finish	ØF										Bright
Steel foot												
PTAF80-12-100	-	80	M12	100	35	14	25	135	10000	✓	30,16 €	
PTAF80-12-150	-	80	M12	150	35	14	25	185	10000	✓	32,70 €	
PTAF80-16-100	-	80	M16	100	35	16	25	135	10000	✓	32,35 €	
PTAF80-16-150	-	80	M16	150	35	16	25	185	10000	✓	35,52 €	
PTAF80-20-100	-	80	M20	100	36	20	25	136	10000	-	34,06 €	
PTAF80-20-150	-	80	M20	150	36	20	25	186	10000	-	37,26 €	
PTAF80-20-200	-	80	M20	200	36	20	25	236	10000	-	40,56 €	
Stainless steel foot												
PAMF80-12-100	PAMF80-12-100/SB	80	M12	100	35	14	25	135	10000	✓	47,12 €	
PAMF80-12-150	PAMF80-12-150/SB	80	M12	150	35	14	25	185	10000	✓	49,94 €	
PAMF80-16-75	PAMF80-16-75/SB	80	M16	75	35	13	25	110	10000	✓	47,80 €	
PAMF80-16-125	PAMF80-16-125/SB	80	M16	125	35	13	25	160	10000	✓	51,41 €	
PAMF80-16-175	PAMF80-16-175/SB	80	M16	175	35	13	25	210	10000	✓	54,96 €	
PAMF80-20-100	PAMF80-20-100/SB	80	M20	100	38	17	25	138	10000	-	54,96 €	
PAMF80-20-150	PAMF80-20-150/SB	80	M20	150	38	17	25	188	10000	-	58,55 €	
PAMF80-20-200	PAMF80-20-200/SB	80	M20	200	38	17	25	238	10000	-	63,89 €	

*Depending on availability - Dimensions in mm

Accepts loads up to 15.000N

PTAF100
PAMF100

- **Tilting foot**
- Tilt up to +/- 5° from vertical
- With non-slip sole
- Materials:

Steel version:

Base: Galvanised sheet steel C40
Spindle: Galvanised steel (nut not supplied)
Sole: Vulcanised NBR rubber, hardness 80° Shore

Stainless steel version:

Base: Stainless sheet steel 304
Spindle: Stainless steel plate 304 (nut not supplied)
Sole: Vulcanised NBR rubber, 80° Shore

Stainless steel version, sanded finish



Large hole allows use of a rawlplug

Large spacing allows use of a hammer drill

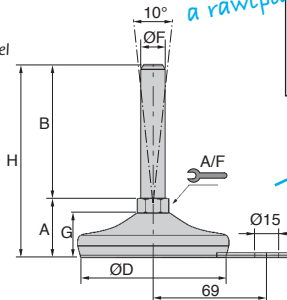

Advantages

- Easy to install due to large distance between shaft and mounting hole

Option

- Other shaft dimensions are available on request

DISCOUNTS

Qty	1+	6+	10+	15+	20+
Disc.	List	-5%	-10%	-15%	On request

Part number	Thread		ØD	ØF	B	A	A/F	G	H	Static load (N)	Stock* Bright	Price each 1 to 5
	Bright	Sanded finish										
Steel foot												
PTAF100-16-100	-	100 M16	100	38	16	28	137,5	15000	✓	37,89 €		
PTAF100-16-150	-	100 M16	150	38	16	28	187,5	15000	✓	40,87 €		
PTAF100-16-200	-	100 M16	200	38	16	28	237,5	15000	✓	42,03 €		
PTAF100-20-100	-	100 M20	100	39	20	28	138,5	15000	-	39,38 €		
PTAF100-20-150	-	100 M20	150	39	20	28	188,5	15000	✓	42,94 €		
PTAF100-20-200	-	100 M20	200	39	20	28	238,5	15000	✓	46,53 €		
PTAF100-24-100	-	100 M24	100	39	24	28	138,5	15000	✓	45,28 €		
PTAF100-24-150	-	100 M24	150	39	24	28	188,5	15000	-	49,13 €		
Stainless steel foot												
PAMF100-16-100	PAMF100-16-100/SB	100 M16	100	39,5	13	30	139,5	15000	✓	68,55 €		
PAMF100-16-150	PAMF100-16-150/SB	100 M16	150	39,5	13	30	189,5	15000	✓	70,70 €		
PAMF100-16-200	PAMF100-16-200/SB	100 M16	200	39,5	13	30	239,5	15000	-	75,69 €		
PAMF100-20-100	PAMF100-20-100/SB	100 M20	100	43,0	17	30	143,0	15000	-	72,82 €		
PAMF100-20-150	PAMF100-20-150/SB	100 M20	150	43,0	17	30	193,0	15000	-	77,16 €		
PAMF100-20-200	PAMF100-20-200/SB	100 M20	200	43,0	17	30	243,0	15000	-	82,13 €		

*Depending on availability - Dimensions in mm

Articulated fixable foot, pressed bolt-down base Ø120 **Sta**

PAMF120 Accepts loads up to 30 000N

Tilting foot

- Tilt up to +/- 5° from vertical
- With non-slip sole
- Materials:
 - Base: Stainless steel sheet 304
 - Spindle: Stainless steel 304 (nut not supplied)
 - Sole: Vulcanised NBR rubber, 80° Shore

Advantages

- Easy to secure due to large distance between shaft and mounting hole

Options

- Other shaft dimensions are available on request

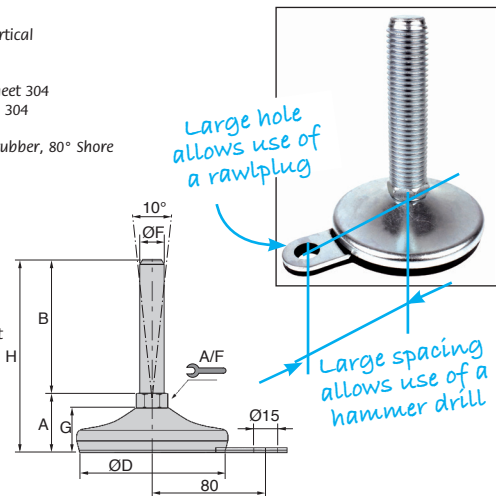

DISCOUNTS

Qty	1+	6+	10+	15+	20+
Disc.	List	-5%	-10%	-15%	On request

Part number	ØD	ØF	B	A	A/F	G	H	Static load (N)	Stock*	Price each 1 à 5
PAMF120-16-100/SS	120	M16	100	47	13	32	147	30000	-	74,13 €
PAMF120-16-150/SS	120	M16	150	47	13	32	197	30000	-	76,20 €
PAMF120-16-200/SS	120	M16	200	47	13	32	247	30000	-	79,83 €
PAMF120-20-100/SS	120	M20	100	47	17	32	147	30000	-	76,50 €
PAMF120-20-150/SS	120	M20	150	47	17	32	197	30000	-	79,50 €
PAMF120-20-200/SS	120	M20	200	47	17	32	247	30000	-	83,37 €
PAMF120-20-250/SS	120	M20	250	47	17	32	297	30000	-	88,17 €
PAMF120-24-150/SS	120	M24	150	49	20	32	199	30000	-	88,17 €
PAMF120-24-200/SS	120	M24	200	49	20	32	249	30000	-	92,64 €
PAMF120-24-250/SS	120	M24	250	49	20	32	299	30000	-	99,90 €

*Depending on availability - Dimensions in mm

Articulated levelling foot, pressed base Ø50 **StaSte**

PTA50

Accepts loads up to 4.000N

PTA50ss

- Tilting foot

- Tilt up to +/- 5° from vertical
- The base of the stainless steel version is available with either a glossy or sandblasted finish

- Materials:

Steel version:

- Base: Galvanised sheet steel C40
- Spindle: Galvanised steel (nut not supplied)
- Sole: Vulcanised NBR rubber, hardness 80° Shore

Stainless steel version:

- Base: Sheet stainless steel 304
- Spindle: Stainless steel 304 (nut not supplied)
- Sole: vulcanised NBR rubber, hardness 80° Shore

Stainless steel version, sanded finish

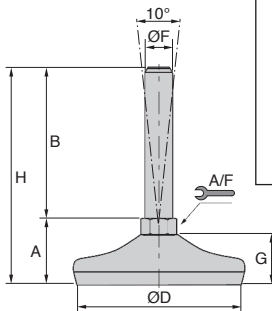

Option

- Other shaft dimensions are available on request

DISCOUNTS

Qty	1+	15+	20+	25+	40+
Disc.	List	-5%	-10%	-15%	On request

Part number		ØD	ØF	B	A	A/F	G	H	Static load (N)	Stock*	Price each 1 to 14
bright	sanded finish										
Steel foot											
PTA50-10-100	-	50	M10	100	29	14	19	129	4000	✓	17,72 €
PTA50-12-100	-	50	M12	100	29	14	19	129	4000	✓	17,72 €
PTA50-12-150	-	50	M12	150	29	14	19	179	4000	-	19,12 €
PTA50-16-75	-	50	M16	75	29	16	19	104	4000	✓	18,19 €
PTA50-16-100	-	50	M16	100	29	16	19	129	4000	✓	19,43 €
PTA50-16-150	-	50	M16	150	29	16	19	179	4000	✓	22,03 €
Stainless steel foot											
PTA50-10-75/SS	PTA50-10-75/SS/SB	50	M10	75	29	14	19	104	4000	✓	19,21 €
PTA50-10-125/SS	PTA50-10-125/SS/SB	50	M10	125	29	14	19	154	4000	✓	21,85 €
PTA50-12-75/SS	PTA50-12-75/SS/SB	50	M12	75	29	14	19	104	4000	✓	19,21 €
PTA50-12-125/SS	PTA50-12-125/SS/SB	50	M12	125	29	14	19	154	4000	✓	21,85 €
PTA50-16-75/SS	PTA50-16-75/SS/SB	50	M16	75	34	13	19	109	4000	✓	22,42 €
PTA50-16-100/SS	PTA50-16-100/SS/SB	50	M16	100	34	13	19	134	4000	✓	23,31 €
PTA50-16-150/SS	PTA50-16-150/SS/SB	50	M16	150	34	13	19	184	4000	-	25,64 €

*Depending on availability - Dimensions in mm

SteSta Articulated levelling foot, pressed base Ø80

Accepts loads up to 10.000N

PTA80
PTA80ss

- **Tilting foot**
- Tilt up to +/- 5° from vertical
- The base of the stainless steel version is available with either a glossy or sandblasted finish
- Materials:

Steel version:

Base: Galvanised sheet steel C40
Spindle: Galvanised steel (nut not supplied)
Sole: Vulcanised NBR rubber, hardness 80° Shore

Stainless steel version:

Base: Stainless steel sheet 30°
Spindle: Stainless steel 304 (nut not supplied)
Sole: Vulcanised NBR rubber, hardness 80° Shore

Option

- Other shaft dimensions are available on request

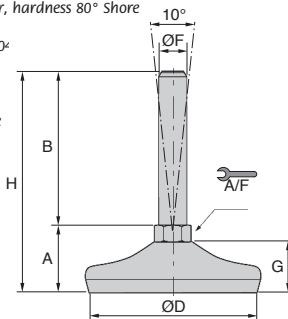

Stainless steel version, sanded finish

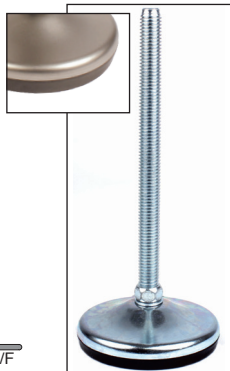

DISCOUNTS

Qty	1+	15+	20+	25+	40+
Disc.	List	-5%	-10%	-15%	On request

Part number		ØD	ØF	B	A	A/F	G	H	Static load (N)	Stock* bright	Price each 1 to 14
bright	sanded finish										
Steel foot											
PTA80-12-100	-	80	M12	100	35	14	25	135	10000	✓	25,19 €
PTA80-12-150	-	80	M12	150	35	14	25	185	10000	-	28,03 €
PTA80-16-100	-	80	M16	100	35	16	25	135	10000	✓	27,83 €
PTA80-16-150	-	80	M16	150	35	16	25	185	10000	-	30,77 €
PTA80-20-100	-	80	M20	100	36	20	25	136	10000	✓	29,22 €
PTA80-20-150	-	80	M20	150	36	20	25	186	10000	✓	32,81 €
PTA80-20-200	-	80	M20	200	36	20	25	236	10000	✓	35,82 €
Stainless steel foot											
PTA80-12-100/SS	PTA80-12-100/SS/SB	80	M12	100	35	14	25	135	10000	✓	38,44 €
PTA80-12-150/SS	PTA80-12-150/SS/SB	80	M12	150	35	14	25	185	10000	✓	41,30 €
PTA80-16-100/SS	PTA80-16-100/SS/SB	80	M16	100	35	13	25	135	10000	✓	41,30 €
PTA80-16-150/SS	PTA80-16-150/SS/SB	80	M16	150	35	13	25	185	10000	✓	44,18 €
PTA80-20-100/SS	PTA80-20-100/SS/SB	80	M20	100	38	17	25	138	10000	-	46,33 €
PTA80-20-150/SS	PTA80-20-150/SS/SB	80	M20	150	38	17	25	188	10000	✓	49,87 €
PTA80-20-200/SS	PTA80-20-200/SS/SB	80	M20	200	38	17	25	238	10000	✓	55,25 €

*Depending on availability - Dimensions in mm

Articulated levelling foot, pressed base Ø100 **Ste** **Sta**

PTA100 PTA100ss

Accepts loads up to 15.000N

- Tilting foot

- tilt up to +/- 5° from vertical
- The base of the stainless steel version is available with either a glossy or sandblasted finish

- Materials:

Steel version:

Base: Galvanised sheet steel C40

Spindle: Galvanised steel (nut not supplied)

Sole: Vulcanised NBR rubber, hardness

80° Shore

Stainless steel version:

Base: Stainless steel

sheet 304

Spindle: Stainless steel

plate 304 (nut not

supplied)

Sole: Vulcanised NBR

rubber, hardness

80° Shore

Stainless steel version, sanded finish

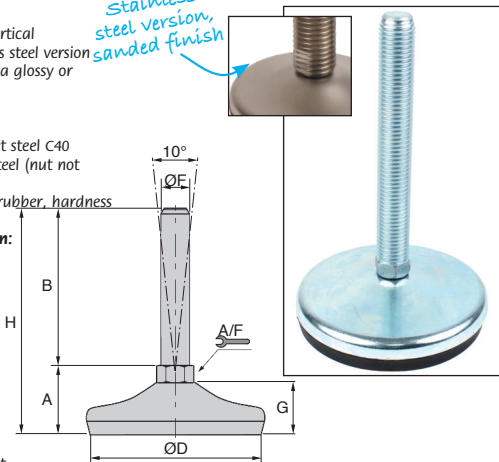

Option

- Other shaft dimensions are available on request

DISCOUNTS

Qty	1+	15+	20+	25+	40+
Disc.	List	-5%	-10%	-15%	On request

Part number		ØD	ØF	B	A	A/F	G	H	Static load (N)	Stock* bright	Price each 1 to 14
bright	sanded finish										
Steel foot											
PTA100-16-100	-	100	M16	100	38,0	16	28	137,5	15000	✓	30,77 €
PTA100-16-150	-	100	M16	150	38,0	16	28	187,5	15000	✓	33,81 €
PTA100-16-200	-	100	M16	200	38,0	16	28	237,5	15000	✓	34,92 €
PTA100-20-100	-	100	M20	100	39,0	20	28	138,5	15000	✓	32,25 €
PTA100-20-150	-	100	M20	150	39,0	20	28	188,5	15000	-	35,82 €
PTA100-20-200	-	100	M20	200	39,0	20	28	238,5	15000	-	39,38 €
PTA100-24-100	-	100	M24	100	39,0	24	28	138,5	15000	-	38,12 €
PTA100-24-150	-	100	M24	150	39,0	24	28	188,5	15000	-	41,83 €
Stainless steel foot											
PTA100-16-100/SS	PTA100-16-100/SS/SB	100	M16	100	39,5	13	30	139,5	15000	✓	59,88 €
PTA100-16-150/SS	PTA100-16-150/SS/SB	100	M16	150	39,5	13	30	189,5	15000	-	61,99 €
PTA100-16-200/SS	PTA100-16-200/SS/SB	100	M16	200	39,5	13	30	239,5	15000	-	67,01 €
PTA100-20-100/SS	PTA100-20-100/SS/SB	100	M20	100	43,0	17	30	143,0	15000	-	64,17 €
PTA100-20-150/SS	PTA100-20-150/SS/SB	100	M20	150	43,0	17	30	193,0	15000	-	68,41 €
PTA100-20-200/SS	PTA100-20-200/SS/SB	100	M20	200	43,0	17	30	243,0	15000	-	73,40 €
PTA100-24-100/SS	PTA100-24-100/SS/SB	100	M24	100	44,0	20	30	144,0	15000	-	69,13 €
PTA100-24-150/SS	PTA100-24-150/SS/SB	100	M24	150	44,0	20	30	194,0	15000	-	71,31 €

*Depending on availability - Dimensions in mm

SteSta Pressed steel articulated foot Ø150

Accepts loads up to 40,000N

PTA150
PTA150ss

- **Levelling foot**
- Brilliant finish (Sand-blasted finish for base of the stainless steel version)
- Materials:

Steel version:

Base: Chromed steel sheet C40
Rod: Chromed steel (nut not supplied)
Sole: Vulcanised rubber NBR hardness 80° Shore

Stainless steel version:

Base: 304 stainless steel, brilliant or sand-blasted finish
Rod: 304 stainless steel (nut not supplied)
Sole: Vulcanised rubber NBR hardness 80° Shore

Sand-blasted stainless-steel version

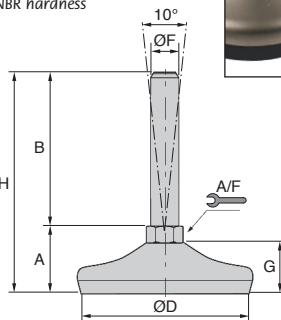

Options

- Other rod sizes are available

DISCOUNTS

Qty	1+	15+	20+	25+	40+
Disc.	List -5%	-10%	-15%		On request

Part number		ØD	ØF	B	A	A/F	G	H	Static load (N)	Price each 1 to 14
bright	sanded finish									
Steel foot										
PTA150-24-100	-	150	M24	100	44	24	35	144	40000	59,78 €
PTA150-24-150	-	150	M24	150	44	24	35	194	40000	63,10 €
PTA150-24-200	-	150	M24	200	44	24	35	244	40000	66,68 €
PTA150-24-250	-	150	M24	250	44	24	35	294	40000	70,03 €
PTA150-30-100	-	150	M30	100	44	30	35	145	40000	65,62 €
PTA150-30-150	-	150	M30	150	44	30	35	195	40000	67,68 €
PTA150-30-200	-	150	M30	200	44	30	35	245	40000	74,50 €
PTA150-30-250	-	150	M30	250	44	30	35	395	40000	83,90 €
Stainless steel foot										
PTA150-24-100/SS	PTA150-24-100/SS/SB	150	M24	100	49	20	35	149	40000	86,15 €
PTA150-24-150/SS	PTA150-24-150/SS/SB	150	M24	150	49	20	35	199	40000	90,89 €
PTA150-24-200/SS	PTA150-24-200/SS/SB	150	M24	200	49	20	35	249	40000	95,63 €
PTA150-24-250/SS	PTA150-24-250/SS/SB	150	M24	250	49	20	35	299	40000	100,38 €
PTA150-30-100/SS	PTA150-30-100/SS/SB	150	M30	100	50	26	35	150	40000	98,04 €
PTA150-30-150/SS	PTA150-30-150/SS/SB	150	M30	150	50	26	35	200	40000	104,97 €
PTA150-30-200/SS	PTA150-30-200/SS/SB	150	M30	200	50	26	35	250	40000	110,80 €
PTA150-30-250/SS	PTA150-30-250/SS/SB	150	M30	250	50	26	35	300	40000	116,58 €

All dimensions in mm

Altri prodotti...



PF30NM

Riduttore a ruota e vite senza fine, fino a 8.8 Nm



PCS62

Pignone a catena - acciaio, 15.875 (DIN 10B-1)



BLH70

Rinvio angolare a L, da 26 a 128 Nm



CFS

Perno folle mini, Miniatura



ZBconique

Ingranaggio conico in plastica, 1:1



MHX

Manicotto esagonale maschiato, Esagonale - acciaio



PR85

Piede fissabile con snodo - poliammide, Ø 83



MRA

Maglia rapida, Acciaio



BSM_LOK

Pressore a molla con esagono incassato,



GGB

Dado ad alette, Cieco



PRF_JL5

Panel accessories, Guarnizione - Ø 5mm



BVR

Battute a vite regolabile, Acciaio

Prodotti correlati