

Attuatore lineare a motore 4A



LAT4

4 ampere

- Motore 4 Ampere 12V CC
- Precisione assiale: $\pm 0,2\text{mm}$
- Vite trapezoidale inox AISI430F
- Vite flessibile in acciaio venduta al metro con puntali grezzi

vite
scorrevole

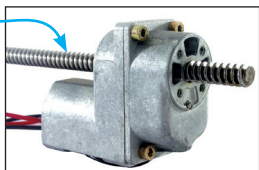

Vantaggi

- I puntali M5 e M4 permettono un facile adattamento
 - Guidati da guaine, i tubi flessibili permettono di controllare valvole, porte o valvole a distanza
- Es: lava-vetri di vetture

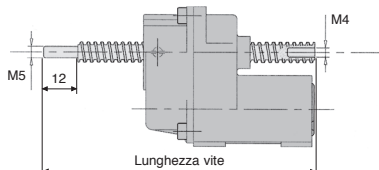

Opzioni

- Varie lunghezze fino a 1000mm
- Vite flessibile venduta al metro

SCONTI PER QUANTITÀ

| | | | |
|-----|-------------|--------------|----|
| Qtà | 1+ | 2+ | 5+ |
| Sc. | Prezzo -15% | Su richiesta | |

| Codice | Rapporto | Passo (mm) | Ø est vite (mm) | Lunghezza vite (mm) | Corsa (mm) | Raggio di curvatura (mm) | Prezzo unit. |
|---|----------|------------|-----------------|---------------------|------------|--------------------------|--------------|
| Vite trapezoidale inox passo 3mm | | | | | | | |
| LAT4-12-3-200 | 1/12 | 3,0 | 8,8 | 200 | 141 | - | 135,34 € |
| LAT4-12-3-300 | 1/12 | 3,0 | 8,8 | 300 | 241 | - | 135,34 € |
| LAT4-12-3-400 | 1/12 | 3,0 | 8,8 | 400 | 341 | - | 135,34 € |
| LAT4-48-3-200 | 1/48 | 3,0 | 8,8 | 200 | 141 | - | 135,34 € |
| LAT4-48-3-300 | 1/48 | 3,0 | 8,8 | 300 | 241 | - | 135,34 € |
| LAT4-48-3-400 | 1/48 | 3,0 | 8,8 | 400 | 341 | - | 135,34 € |
| LAT4-108-3-200 | 1/108 | 3,0 | 8,8 | 200 | 141 | - | 135,34 € |
| LAT4-108-3-300 | 1/108 | 3,0 | 8,8 | 300 | 241 | - | 135,34 € |
| LAT4-108-3-400 | 1/108 | 3,0 | 8,8 | 400 | 341 | - | 135,34 € |
| Vite trapezoidale inox passo 10mm | | | | | | | |
| LAT4-12-10-200 | 1/12 | 10,0 | 7,9 | 200 | 141 | - | 135,34 € |
| LAT4-12-10-300 | 1/12 | 10,0 | 7,9 | 300 | 241 | - | 135,34 € |
| LAT4-12-10-400 | 1/12 | 10,0 | 7,9 | 400 | 341 | - | 135,34 € |
| LAT4-48-10-200 | 1/48 | 10,0 | 7,9 | 200 | 141 | - | 135,34 € |
| LAT4-48-10-300 | 1/48 | 10,0 | 7,9 | 300 | 241 | - | 135,34 € |
| LAT4-48-10-400 | 1/48 | 10,0 | 7,9 | 400 | 341 | - | 135,34 € |
| LAT4-108-10-200 | 1/108 | 10,0 | 7,9 | 200 | 141 | - | 135,34 € |
| LAT4-108-10-300 | 1/108 | 10,0 | 7,9 | 300 | 241 | - | 135,34 € |
| LAT4-108-10-400 | 1/108 | 10,0 | 7,9 | 400 | 341 | - | 135,34 € |
| Vite flessibile in acciaio passo 3,5mm | | | | | | | |
| LAT4-12-FLX | 1/12 | 3,5 | 6,2 | 1000 | 941 | 60 | 135,34 € |
| LAT4-48-FLX | 1/48 | 3,5 | 6,2 | 1000 | 941 | 60 | 135,34 € |
| LAT4-108-FLX | 1/108 | 3,5 | 6,2 | 1000 | 941 | 60 | 135,34 € |

Dimensioni in mm

Tabella delle prestazioni

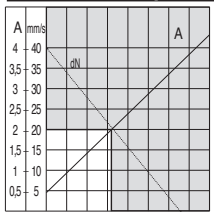

LAT4-12

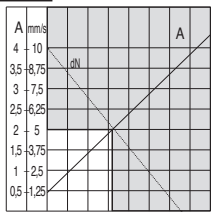

LAT4-48

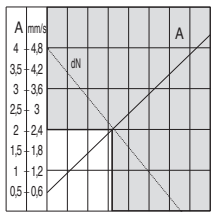

LAT4-108

4A Ciclo di funzionamento (12): 20% On 80% Off

Importante: motore fornito solo a 12 Vc.c

Nota:

- Potenza ottimale ottenuta al 50% della corrente max. (vedere zona chiara del grafico)
- Utilizzo a 70° C max.
- Protettore termico su richiesta

Attenzione, queste tabelle corrispondono alle viti trapezoidali con passo 3mm. Per il passo di 10mm, occorre dividere i carichi per 10/3 e moltiplicare le velocità per 10/3 (lo stesso per le viti con passo 3,5mm con fattore 3,5/3).

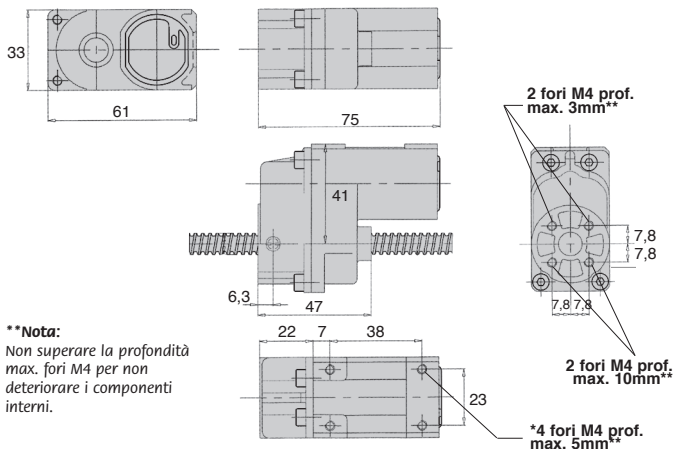

****Nota:**

Non superare la profondità max. fori M4 per non deteriorare i componenti interni.

Altri prodotti...



Pastrina di riscontro
piatta per chiusura,
22mm



Motoriduttore DC 12V
e 24V DC, da 1.5 a 2
Nm



Pignone tendicatena,
Ruota dentata in
acciaio



Cinghia aperta al
metro tipo T, T5
Poliuretano armatura
in acciaio



Guida mini Drylin® N,
Larghezza 17 mm



Cuscinetto radiale a
sfere, Inox



Spazzola strip,
Lunghezza 3m



Anelli d'arresto per
alberi, Anello tipo E



Cerniera ad avvitare
estetica, Alluminio



Maniglia e battuta per
porta, Modulare



Sfera portante a
incastro con flangia,
Forte



Visualizzatore
multifunzione,
Supporto - montaggio
ortogonale

Prodotti correlati

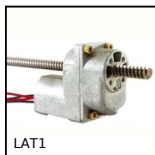

Attuatore lineare a
motore 1A, 1 ampere



Mini martinetto
motorizzato 1A, 1
ampere



Mini martinetto
motorizzato 4A, 4
ampere



Mini martinetto
motorizzato 4A, 4
ampere