

Attuatore lineare a motore 1A Stock

LAT1

1 ampere

- Motore 1 Ampere da 12V a 24V CC
- Precisione assiale: $\pm 0,2\text{mm}$
- Vite trapezoidale inox AISI430F
- Vite flessibile in acciaio venduta al metro con puntali grezzi

Vite scorrevole

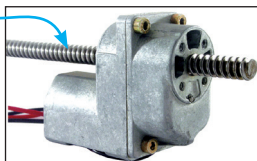

Vantaggi

- I puntali M5 e M4 permettono un facile adattamento
- Guidati da guaine, i tubi flessibili permettono di controllare valvole, porte o valvole a distanza
- Es: lava-vetri di vetture

Opzioni

- Varie lunghezze fino a 1000mm
- Vite flessibile venduta al metro

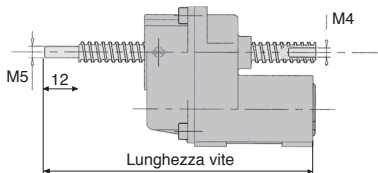

SCONTI PER QUANTITÀ

Qtà	1+	2+	5+
Sc.	Prezzo	-15%	Su richiesta

Codice	Rapporto	Passo (mm)	Ø est vite (mm)	Lunghezza vite (mm)	Corsa (mm)	Raggio di curvatura (mm)	Stock*	Prezzo unit.
Vite trapezoidale inox passo 3mm								
LAT1-12-3-200	1/12	3,0	8,8	200	141	-	✓	135,34 €
LAT1-12-3-300	1/12	3,0	8,8	300	241	-	-	135,34 €
LAT1-12-3-400	1/12	3,0	8,8	400	341	-	-	135,34 €
LAT1-48-3-200	1/48	3,0	8,8	200	141	-	-	135,34 €
LAT1-48-3-300	1/48	3,0	8,8	300	241	-	-	135,34 €
LAT1-48-3-400	1/48	3,0	8,8	400	341	-	-	135,34 €
LAT1-108-3-200	1/108	3,0	8,8	200	141	-	✓	135,34 €
LAT1-108-3-300	1/108	3,0	8,8	300	241	-	✓	135,34 €
LAT1-108-3-400	1/108	3,0	8,8	400	341	-	✓	135,34 €
Vite trapezoidale inox passo 10mm								
LAT1-12-10-200	1/12	10,0	7,9	200	141	-	△	135,34 €
LAT1-12-10-300	1/12	10,0	7,9	300	241	-	-	135,34 €
LAT1-12-10-400	1/12	10,0	7,9	400	341	-	✓	135,34 €
LAT1-48-10-200	1/48	10,0	7,9	200	141	-	-	135,34 €
LAT1-48-10-300	1/48	10,0	7,9	300	241	-	-	135,34 €
LAT1-48-10-400	1/48	10,0	7,9	400	341	-	-	135,34 €
LAT1-108-10-200	1/108	10,0	7,9	200	141	-	-	135,34 €
LAT1-108-10-300	1/108	10,0	7,9	300	241	-	-	135,34 €
LAT1-108-10-400	1/108	10,0	7,9	400	341	-	-	135,34 €
Vite flessibile in acciaio passo 3,5mm								
LAT1-12-FLX	1/12	3,5	6,2	1000	941	60	-	135,34 €
LAT1-48-FLX	1/48	3,5	6,2	1000	941	60	-	135,34 €
LAT1-108-FLX	1/108	3,5	6,2	1000	941	60	-	135,46 €

*Nei limiti delle disponibilità - Dimensioni in mm

Tabella delle prestazioni

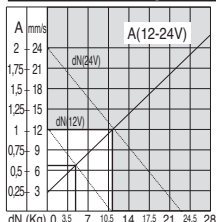

LAT1-12

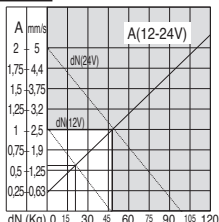

LAT1-48

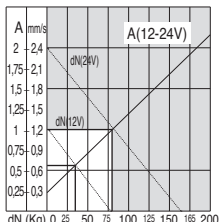

LAT1-108

1A Ciclo di funzionamento (12): 80% On 20% Off

1A Ciclo di funzionamento (24): 50% On 50% Off

Nota:

- Potenza ottimale ottenuta al 50% della corrente max. (vedere zona chiara del grafico)
- Utilizzo a 70° C max.
- Protettore termico su richiesta

Attenzione, queste tabelle corrispondono alle viti trapezoidali con passo 3mm. Per il passo di 10mm, occorre dividere i carichi per 10/3 e moltiplicare le velocità per 10/3 (lo stesso per le viti con passo 3,5mm con fattore 3,5/3).

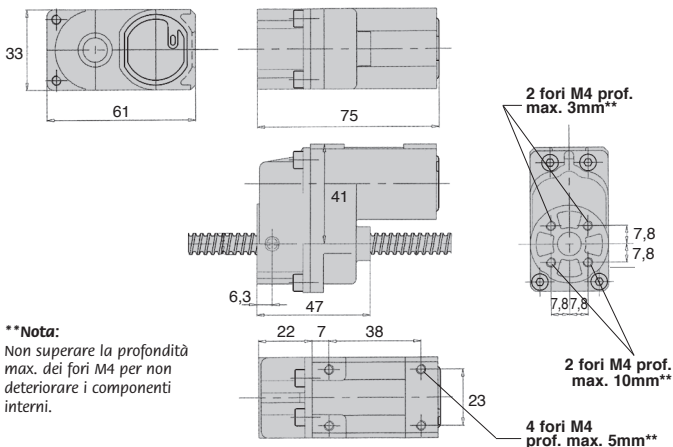

**Nota:

Non superare la profondità max. dei fori M4 per non deteriorare i componenti interni.

Altri prodotti...



E50

Riduttore a rinvio
angolare, da 3 a 41
Nm



GGB

Dado ad alette, Cieco

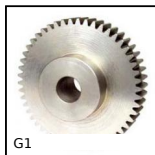

G1

Ingranaggio dritto
acciaio, Acciaio
20NCD2



AT5-BAR

Barra dentata, AT5



CHAEss

Cerniera estetica, Inox



PRF4545_P

Profilato alluminio per
camera bianca, 45 x
45 mm



BS2

Panamech, Multi-
Beam, Alluminio - con
vite a pressione



M1

Coppia ruota e vite
senza fine , Acciaio
non temprato

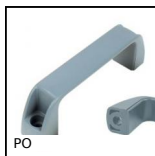

PO

Maniglia a ponte -
Multi-settore, Foro
liscio



TB_ECO

Ingranaggio conico -
Acciaio C43 - ECO, 3:1



SCR

Accessori per ventosa,
Inserto per ventosa -
Vite cava



FBL6000_K13

Spazzola al metro,
Polipropilene nero
striato (PP)

Prodotti correlati



LVT

Mini martinetto
motorizzato 1A, 1
ampere



LVT

Mini martinetto
motorizzato 1A, 1
ampere

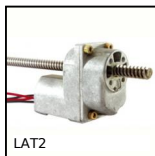

LAT2

Attuatore lineare a
motore 2A, 2 ampere

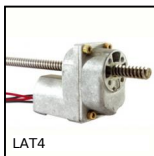

LAT4

Attuatore lineare a
motore 4A, 4 ampere