

- Chiusura tramite aggancio

- Materiale:

Acciaio zincato bianco

Assemblaggio

- GE14-ZB: con gancio AC101-ZB quota X=53.9mm per una tensione di 350N

Vantaggi

- Buona flessibilità d'utilizzo:
- Permette numerose manovre senza allentare il serraggio

Info.

- Venduto a multipli, contattateci

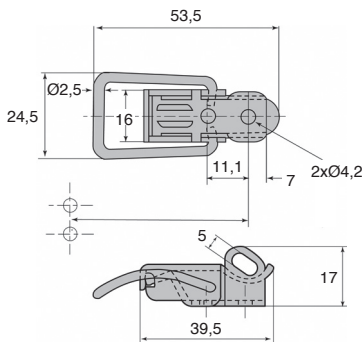
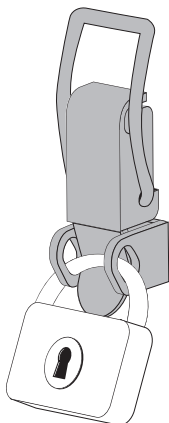

SCONTI PER QUANTITÀ

| Qtà | 1+ | 51+ | 101+ | 250+ | 400+ | 500+ |
|------------|------|------|------|------|--------------|------|
| Sc. Prezzo | -10% | -15% | -20% | -25% | Su richiesta | |

| Codice | Ø filo | Spessore leva | Spessore Staffa di fissaggio | Tensione max. (N) | Massa (g) | Stock* | Prezzo unit. da 1 a 50 |
|------------------------------------|--------|---------------|------------------------------|-------------------|-----------|--------|------------------------|
| Modello con porta-serratura | | | | | | | |
| GE14-ZB | 2,5 | 15/10 | 20/10 | 500 | 21,9 | ✓ | 3,39 € |

*Nei limiti delle disponibilità - Dimensioni in mm

Altri prodotti...



NCT
Giunto di collegamento, Ad angolo fisso



AT10-25ECO
Puleggia dentata di posizionamento tipo AT, Serie economica - AT10 a...



BFD
Perno ad innesto per boccia, +180°C



ACAss
Albero scanalato Inox 304, Inox



FAD
Piede snodato semplice, Piede inclinabile senza suola antiscivolo



SDG
Supporto con tirante ad occhio, Plastica



E20
Riduttore a rinvio angolare, da 0.60 a 3.84 Nm

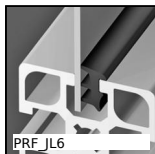

PRF_JL6
Panel accessories, Guarnizione - Ø 6mm

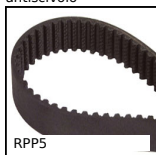

RPP5
Cinghia di trasmissione RPP,



CABPVC
Cavo acciaio galvanizzato con PVC



HW_HT
Guida su semi-binari, Binario



INO
Ingranaggio interno, Acciaio 20NCD2

Prodotti correlati

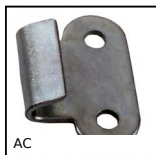

AC
Piastrina di riscontro, 15mm



AC
Piastrina di riscontro, 15mm

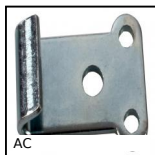

AC
Piastrina di riscontro, 15mm

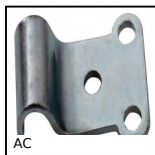

AC
Piastrina di riscontro, 15mm