



DOMI120

Carico C1 fino a 1000 N

- Carichi elevati
- Coefficienti di attrito favorevoli
- Guida a scorrimento di grande qualità
- Trascinamento con ridotto gioco
- Regolazione fine 0,05mm
- Lunghezza assi standard
- Sistema di comando semplice

Utilizzo

- Regolazione fine della testa di brasatura/teste di saldatura/testine laser
- Montaggio di stampanti a getto d'inchiostro
- Regolazione video camere di misurazione
- Regolazione di unità di lavorazione (teste di fresatura, assi di fresatura...)
- Puntamento di ugelli di bruciatori
- Regolazione di testine laser
- Spostamento di fine corsa
- Spostamento centrato di guide laterali (carrello con mandrino sinistra-destra)

Opzione

- Altre corse disponibili, contattateci
- Per un contatore numerico su una slitta di regolazione verticale, sostituire /XY con /Z nel codice prodotto



Carrello singolo DOMI120

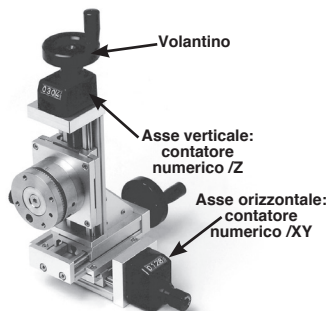
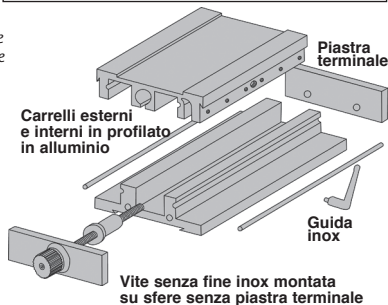

Slitte con volantini e contatori DOMI120-CV (esempio d'applicazione)

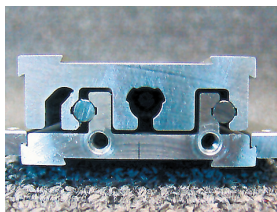

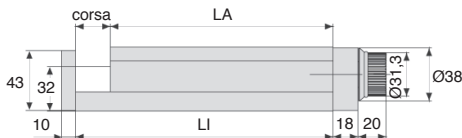

M5 DIN 7984

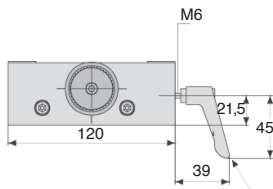
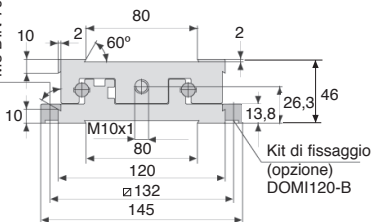

Leva di serraggio
(opzione)
DOMI120-LEVIER

Carichi ammissibili DOMINO 120

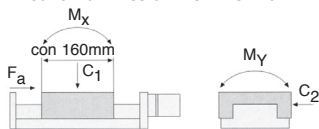

SCONTI PER QTA

Qtà	1+	2+	3+
Sc.	Prezzo -20% Su richiesta		

Codice	LA	LI	Corsa	Carichi ammissibili							Prezzo Unit.
				Passo (mm)	C1 (N)	C2 (N)	FA (N)	Mx (Nm)	My (Nm)	Mz (Nm)	
Slitta singola											
DOMI120-25	160	185	25	1	1000	700	300	15	20	12	771,12 €
DOMI120-50	160	210	50	1	1000	700	300	15	20	12	783,97 €
DOMI120-75	160	235	75	1	1000	700	300	15	20	12	798,96 €
DOMI120-100	160	260	100	1	1000	700	300	15	20	12	809,67 €
Slitta con contatore e volantino											
DOMI120-25-CV/XY	160	185	25	1	1000	700	300	15	20	12	1 073,14 €
DOMI120-50-CV/XY	160	210	50	1	1000	700	300	15	20	12	1 036,98 €
DOMI120-75-CV/XY	160	235	75	1	1000	700	300	15	20	12	1 100,98 €
DOMI120-100-CV/XY	160	260	100	1	1000	700	300	15	20	12	1 133,83 €

Dimensioni in mm



DOMI120

Per slitta di regolazione DOMINO 120

- Il **kit di fissaggio** è necessario per fissare la slitta regolabile DOMINO alla superficie di assemblaggio
- La **piastra** funge da adattatore per applicazioni personalizzate e può essere lavorata dal cliente

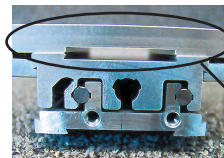

Piastra di supporto utensili



Leva di serraggio
DOMI120-LEVIER



Kit di fissaggio
DOMI120-B

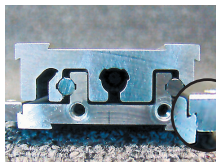

Kit di fissaggio

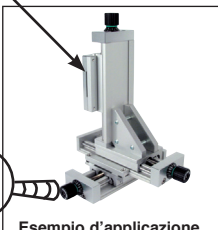

Esempio d'applicazione



Piastra
DOMI120-M

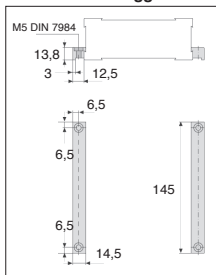

Kit di fissaggio DOMI 120-B

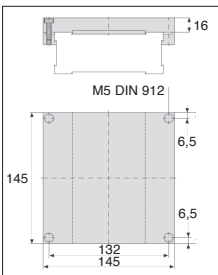

Piastra DOMI 120-M

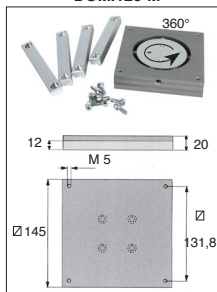

Pi DOMI 120-PT

SCONTI PER QTÀ

Qtà	1+	2+	3+
Sc.	Prezzo -20% Su richiesta		

Codice	Tipo	Prezzo unit.
DOMI120-B	Kit di fissaggio	36,41 €
DOMI120-M	Piastra	130,66 €
DOMI120-LEVIER	Leva di serraggio	34,27 €
DOMI120-PT	Piatto girevole	563,34 €

Dimensioni in mm



Per slitta di regolazione DOMINO 120

DOMI120

- I **kit di raccordo** sono necessari per collegare
due slitte regolabili DOMINO

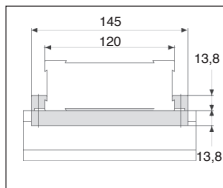

Kit di raccordo
DOMI 120-XY



Kit di raccordo
DOMI 120-XY



Kit di raccordo
DOMI 120-XZ

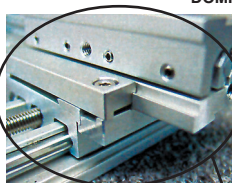

Kit di raccordo X-Y

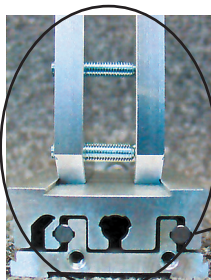

Kit di raccordo X-Z

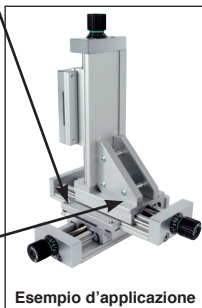

Esempio d'applicazione

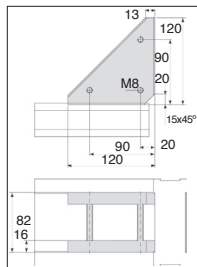

Kit di raccordo
DOMI 120-XZ

SCONTI PER QTÀ

Qtà	1+	2+	3+
Sc.	Prezzo -20% Su richiesta		

Codice	Tipo	Prezzo unit.
DOMI120-XY	Kit di raccordo X-Y	100,67 €
DOMI120-XZ	Kit di raccordo X-Z	128,52 €

Dimensioni in mm

Altri prodotti...



PLB

Distanziatore cilindrico, Ottone



RPCtcss

Ruota girevole a foro centrale, Inox - Poliammide - a doppio bloccag...



HCV

Sistema di guida su binario a V Simple Select®, con carrello



MCL

Manicotto cilindrico maschiato, Cilindrico - inox



DOMI80

Kit di raccordo, Kit di raccordo XY

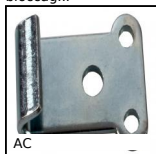

AC

Piastrina di riscontro, 15mm

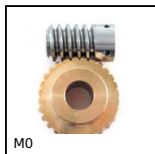

M0

Coppia ruota e vite senza fine, Bronzo



CHM30-MOT

Motoriduttore AC asincrono da 0,09 a 0,22kW, 0.09 a 0.22kW



PT880

Pignone di trazione, Serie 880



SUA4_L

Giunzione per catena al metro, Falsa maglia



ACLCHARJ

Cerniera ad avvitare, Adjusts in 2 directions



NIN

Dado autofrenante, Acciaio

Prodotti correlati



DOMI120

Accessori di collegamento, Leva di serraggio



DOMI_MD

Tavola rotante di regolazione Domino, 55/1



DOMI120

Accessori di collegamento, Kit di fissaggio



DOMI120

Accessori di collegamento, Piastra