

Miniature ballscrew and nut

BSPM

Rolled ballscrew diameters from 6 to 14mm

- **Rolled ballscrew, precision class 7**
- Max axial backlash : 0.05mm
- Supplied with the nut flange to the left
- Machined to be compatible with BEK bearings (Fig A) and BEF bearings (Fig B). No keyway.
- Screw manufactured from steel

Options

- Shorter lengths available on request
- Nut with flange on right

Info

- This part number includes 1 ballscrew and 1 nut

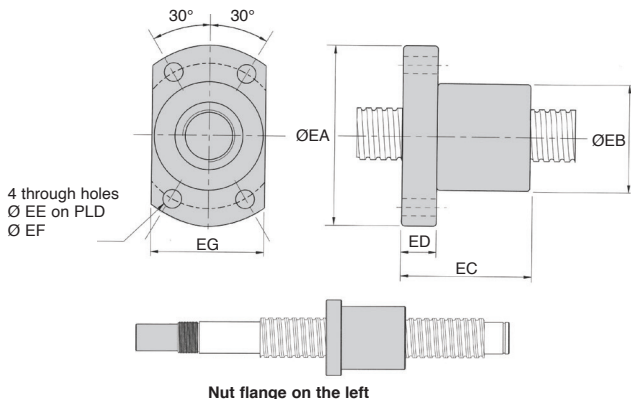
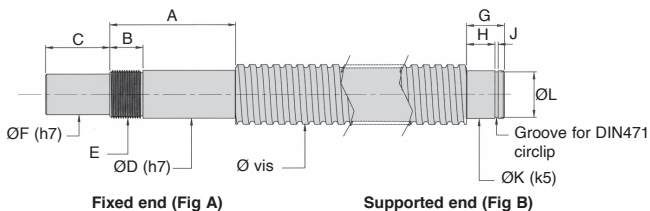

Dimensions in mm

Nut

BSPM

- Basic nut, precision class 7
- Nut has no lubrication point

Info

- Not available separately
- Do not disassemble
- Delivered non lubricated, user should apply lubricant before use.

Accessories

- Bearing housing
BEF (tome 3 p.322) and
BEK (tome 3 p.323)

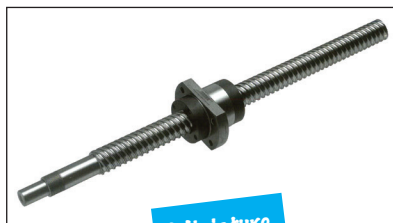

Miniature

DISCOUNTS

Qty	1+	2+	5+
Disc.	List	-5%	On request

Part number	A	B	C	D	E	F	G	H	J	K	L
BSPM0601R-150	Drawing supplied by the user										
BSPM0801R-200	29	9	8	6	M6x0,75	4	9	6	0,8	6	5,7
BSPM1002R-300	34	11	10	8	M8x1	6	9	6	0,8	6	5,7
BSPM1202R-600	38	13	15	10	M10x1	8	10	7	0,9	8	7,6
BSPM1402R-700	38	13	15	12	M12x1	10	10	7	0,9	8	7,6

Part number	ØScrew	Pitch	Max length	Length	Axial rigidity (N/µm)	Price each. 1 screw + 1 nut
BSPM0601R-150	6	1	150	150	55	984,12 €
BSPM0801R-200	8	1	200	200	72	872,92 €
BSPM1002R-300	10	2	300	300	90	993,63 €
BSPM1202R-600	12	2	600	600	110	1 193,29 €
BSPM1402R-700	14	2	700	700	120	1 195,29 €

Part number for screw	ØScrew	Pitch	Load								Dyn Ca (kN)	Stat Coa (kN)	Not available separately
			EA	EB	EC	ED	EE	EF	EG				
BSPM0601R-150	6	1	24	12	15	3,5	3,4	18	16	0,73	1,21		
BSPM0801R-200	8	1	27	14	16	4	3,4	21	18	0,93	1,73		
BSPM1002R-300	10	2	35	18	28	5	4,5	27	22	1,85	3,05		
BSPM1202R-600	12	2	37	20	28	5	4,5	29	24	1,73	3,17		
BSPM1402R-700	14	2	40	21	23	6	5,5	31	26	2,87	6,33		

Dimensions in mm

Bearing housing for miniature ballscrew

BEF

Non fixed end

- Bearing designed to receive the free end of a miniature ballscrew (refer to BSPM Fig B)
- Fitted with a deep groove ball bearing
- Material :
Blackened steel



Assembly

- Use the circlip supplied to block the axial position of the ballscrew

Info

- There is no product available for 6mm ballscrews

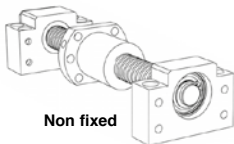
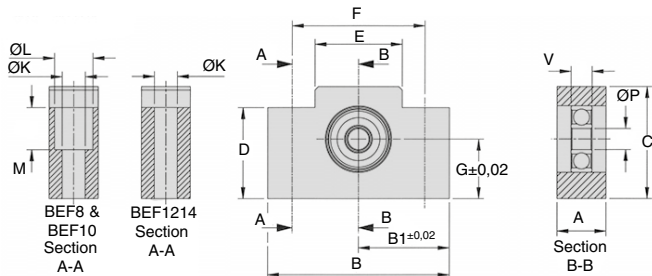

DISCOUNTS

Qty	1+	2+	5+
Disc.	List	-5%	On request

Part number	Screw Ø	A	B	B1	C	D	E	F	G
BEF8	8	14	42	21	25	20	18	30	13
BEF10	10	14	52	26	32	24	25	38	17
BEF1214	12 et 14	20	70	35	43	24	36	52	25

Part number	ØK	ØL	M	ØP	V	Bearing	Price each
BEF8	5,5	9,5	11	6	6	606ZZ	191,19 €
BEF10	6,6	11	12	6	6	606ZZ	191,19 €
BEF1214	9	-	-	8	7	608ZZ	191,19 €

Dimensions in mm

Bearing housing for miniature ballscrew

Fixed end

BEK

- Bearing designed to receive the fixed end of a miniature ballscrew (refer to BSPM Fig A)
- Fitted with 2 angular contact bearings
- Accurate radial and axial positioning of the ballscrew
- Material :
Blackened steel

Assembly

- Locking nut should be fully tightened and secured with the grub screw

Info

- There is no product available for 6mm ballscrews

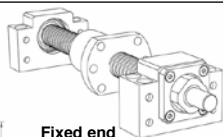

Fixed end

BEK12 & BEK14

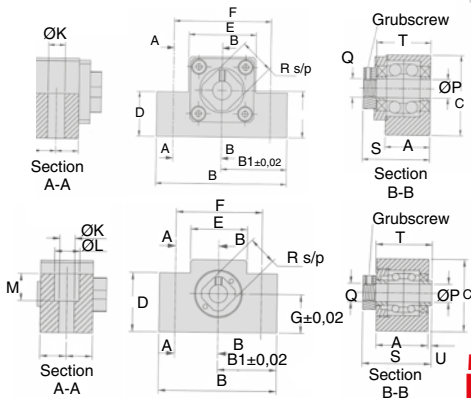

BEK8 & BEK10

DISCOUNTS

Qty	1+	2+	5+
Disc.	List	-5%	On request

Part number	Ø Screw	A	B	B1	C	D	E	F	G
BEK8	8	20	42	21	25	20	18	30	13
BEK10	10	23	52	26	32	24	25	38	17
BEK12	12	24	70	35	43	24	36	52	25
BEK14	14	24	70	35	43	24	36	52	25

Part number	Ø Screw	ØL	M	ØP	Q	R	S	T	U	Price each
BEK8	5,5	9,5	11	6	M6x0,75	12	27	22	1,5	317,23 €
BEK10	6,6	11	12	8	M8x1	14	31,3	25	1,3	299,15 €
BEK12	9	-	-	10	M10x1	16	35,4	27	-	290,26 €
BEK14	9	-	-	12	M12x1	19	35,3	27	-	299,15 €

Dimensions in mm