

ACZB
ACss

in acciaio
o inox

- Chiusura tramite aggancio

- Materiale:

Acciaio zincato bianco
o inox 303

Selezione

- Componete voi stessi il sistema di chiusura piastrina/chiusura a leva: verificate la larghezza interna dell'anello e selezionate una piastrina con larghezza inferiore

Info.

- Venduto a multipli, contattateci

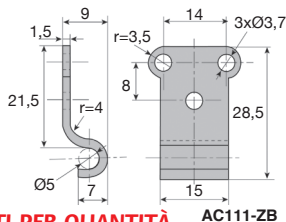
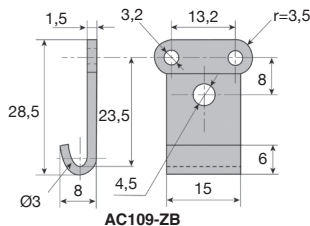
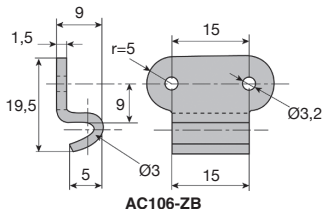
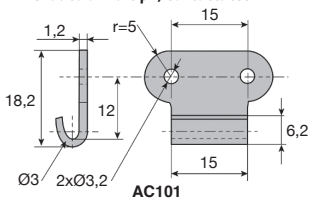

SCONTI PER QUANTITÀ

Qtà	1+	51+	101+	250+	400+	500+
Sc. Prezzo	-10%	-15%	-20%	-25%	Su richiesta	

Codice	Ideale per chiusura a leva	Massa (g)	Stock*	Prezzo unit. da 1 a 50
Modello in acciaio				
AC101-ZB	GE14-ZB	4,7	✓	0,59 €
AC106-ZB	GE14-ZB	5,2	✓	0,95 €
AC109-ZB	GE14-ZB	6,2	✓	0,82 €
AC111-ZB	GE14-ZB	6,8	✓	1,28 €
Modello in acciaio inossidabile				
AC101-SS	GE1006-SS	4,7	✓	0,59 €

*Nei limiti delle disponibilità - Dimensioni in mm

- Chiusura tramite aggancio

- Materiale:

Acciaio zincato bianco
o inox 303

Selezione

- Componete voi stessi il sistema di chiusura piastrina/chiusura a leva: verificate la larghezza interna dell'anello e selezionate una piastrina con larghezza inferiore

Info.

- Venduto a multipli, contattateci

in acciaio
o inox

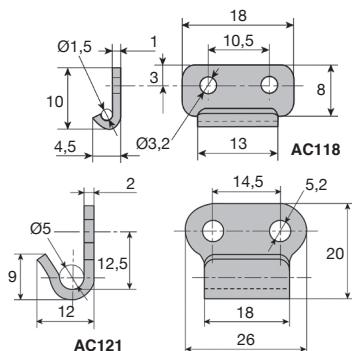
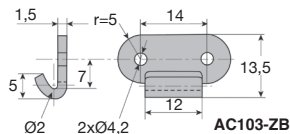
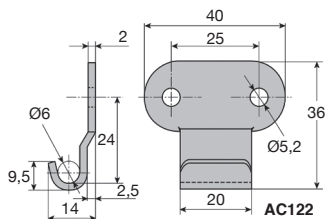

SCONTI PER QUANTITÀ

Qtà	1+	51+	101+	250+	400+	500+
Sc. Prezzo	-10%	-15%	-20%	-25%	Su richiesta	

Codice	Ideale per chiusura a leva	Massa (g)	Stock*	Prezzo unit. da 1 a 50
Modello in acciaio				
AC103-ZB	-	3,4	-	0,27 €
AC118-ZB	GE18-ZB	1,5	✓	0,20 €
AC121-ZB	GE5-ZB	9,4	✓	0,44 €
AC122-ZB	GP22-ZB et GP23-ZB	1,9	✓	0,82 €
Modello in acciaio inossidabile				
AC118-SS	GE18-SS	1,5	✓	0,37 €
AC121-SS	GE5-SS	9,4	✓	1,18 €
AC122-SS	GP22-SS et GP23-SS	1,9	✓	2,29 €

*Nei limiti delle disponibilità - Dimensioni in mm

Altri prodotti...

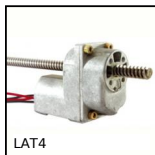

LAT4

Attuatore lineare a motore 4A, 4 ampere



CHAGC-AL

Cerniera ad avvitare, Sfilabile



GGP

Vite ad alette, Tecnopolimero con inserto in acciaio



DCA

Ventosa, nitrile



EHD08-3

Riduttore coassiale, da 20 a 50 Nm



SH2

Ingranaggio elicoidale ad assi paralleli, Acciaio 20NCD2



TFR

Tenditore rigido, Fisso



LWL

Guida lineare a sfere - Sfere inox, Carello - da 514 N a 16700 N



RDS

Rondella di sicurezza Hygienic Usit®, Inox



CM_CO

Attrezzi Hygienic Usit® and Hygienic Design®, Protective



UTKpwrr

Guida lineare Utilitrack®, Profilo guida a V



LVT

Mini martinetto motorizzato 1A, 1 ampere

Prodotti correlati



GP

Chiusura a leva molla a trazione compensata, Standard



GP

Chiusura a leva molla a trazione compensata, Con porta-lucchetto