

ACZB
ACss

in acciaio
o inox

- Chiusura tramite aggancio

- Materiale:

Acciaio zincato bianco
o inox 303

Selezione

- Componete voi stessi il sistema di chiusura piastrina/chiusura a leva: verificate la larghezza interna dell'anello e selezionate una piastrina con larghezza inferiore

Info.

- Venduto a multipli, contattateci

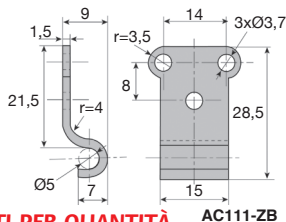
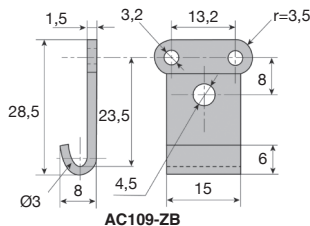
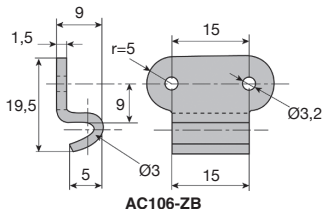
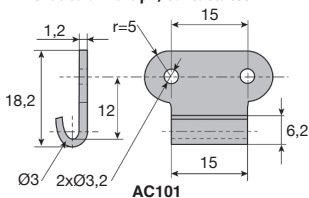

SCONTI PER QUANTITÀ

Qtà	1+	51+	101+	250+	400+	500+
Sc. Prezzo	-10%	-15%	-20%	-25%	Su richiesta	

Codice	Ideale per chiusura a leva	Massa (g)	Stock*	Prezzo unit. da 1 a 50
Modello in acciaio				
AC101-ZB	GE14-ZB	4,7	✓	0,59 €
AC106-ZB	GE14-ZB	5,2	✓	0,95 €
AC109-ZB	GE14-ZB	6,2	✓	0,82 €
AC111-ZB	GE14-ZB	6,8	✓	1,28 €
Modello in acciaio inossidabile				
AC101-SS	GE1006-SS	4,7	✓	0,59 €

*Nei limiti delle disponibilità - Dimensioni in mm

- Chiusura tramite aggancio

- Materiale:

Acciaio zincato bianco
o inox 303

Selezione

- Componete voi stessi il sistema di chiusura piastrina/chiusura a leva: verificate la larghezza interna dell'anello e selezionate una piastrina con larghezza inferiore

Info.

- Venduto a multipli, contattateci

in acciaio
o inox

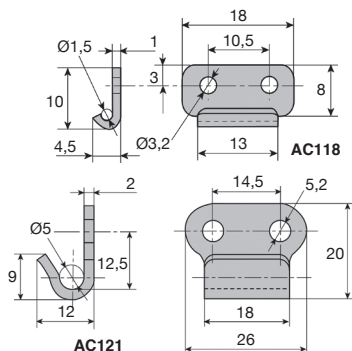
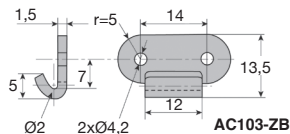
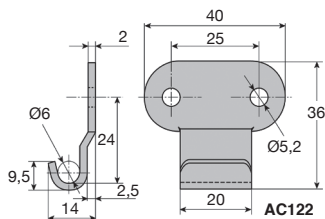

SCONTI PER QUANTITÀ

Qtà	1+	51+	101+	250+	400+	500+
Sc. Prezzo	-10%	-15%	-20%	-25%	Su richiesta	

Codice	Ideale per chiusura a leva	Massa (g)	Stock*	Prezzo unit. da 1 a 50
Modello in acciaio				
AC103-ZB	-	3,4	-	0,27 €
AC118-ZB	GE18-ZB	1,5	✓	0,20 €
AC121-ZB	GE5-ZB	9,4	✓	0,44 €
AC122-ZB	GP22-ZB et GP23-ZB	1,9	✓	0,82 €
Modello in acciaio inossidabile				
AC118-SS	GE18-SS	1,5	✓	0,37 €
AC121-SS	GE5-SS	9,4	✓	1,18 €
AC122-SS	GP22-SS et GP23-SS	1,9	✓	2,29 €

*Nei limiti delle disponibilità - Dimensioni in mm

Altri prodotti...

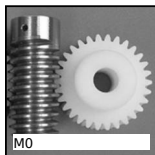

Coppia ruota e vite senza fine, Plastica lavorata (delrin)



Terminale rapido per cavi, A occhio



Ingranaggio dritto di precisione, Inox 316



Perno folle, Standard - acciaio



Ingranaggio conico in plastica stampata, 2:1



Pistoncino a molla, Da saldare - Acciaio



Ingranaggio dritto ottone, Ottone CuZn39Pb3



Guida lineare Utilitrack®, Profilo guida a V



Piastra di giunzione per cinghia T, T10



Elementi di giunzione, Piastra di giunzione - 45x90 mm



Piede fissabile con snodo - poliammide, Ø 123



Maniglia e battuta per porta, Maniglia ergonomica

Prodotti correlati



Chiusura a leva, Standard