

Manual worm/wheel gearbox



RVM14

Manual torque up to 5 Nm

- **Manually operated gearbox**
- Ratios from 1:1 to 23:1
- **Materials:**
Housing: Die cast zinc
Worm/wheel: Case hardened steel

NUOVO!



Info

- Not suitable for motorised applications

Accessories

- MBEX handle (tome 2 p.125)
- AHX hexagonal shaft (tome 2 p.124)

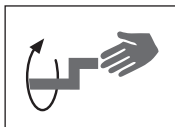

For manual operation only

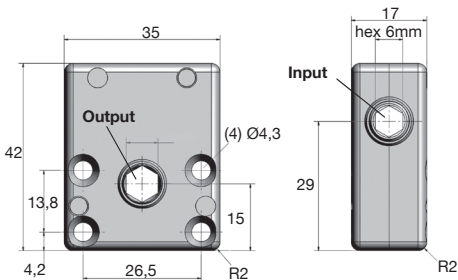

DISCOUNTS

Qty	1+	10+	25+	50+
Disc.	List	-5%	-15%	On request

Part number	Ratio	Input/ Output	Max torque (Nm)	Self locking	Stock*	Price each 1 to 9
RVM14-1	1:1	hex 6mm	2,0	No	✓	130,78 €
RVM14-2	2:1	hex 6mm	2,0	No	✓	130,78 €
RVM14-2.8	2,8:1	hex 6mm	2,5	No	-	117,17 €
RVM14-4.33	4,33:1	hex 6mm	2,0	Yes	✓	117,17 €
RVM14-10	10:1	hex 6mm	4,0	Yes	✓	130,78 €
RVM14-14	14:1	hex 6mm	5,0	Yes	✓	130,78 €
RVM14-15	15:1	hex 6mm	4,0	Yes	✓	127,19 €
RVM14-23	23:1	hex 6mm	3,0	Yes	-	117,17 €

*Depending on availability - Dimensions in mm



Manually operated gearbox

Manual torque up to 17 Nm

RVM25

- Compact manually operated gearbox
- Ratios from 1:1 to 30:1
- Material:
Housing: Die cast zinc

Info

- Not suitable for motorised applications

Accessories

- MBEX handle (tome 2 p.125)
- AHX hexagonal shaft (tome 2 p.124)



NUOVO!

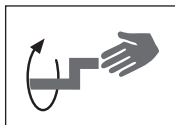
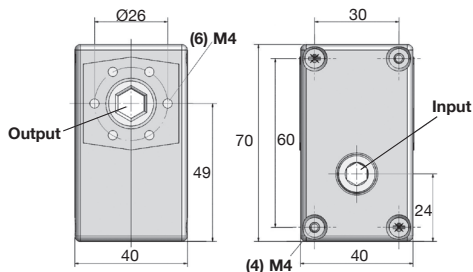

For manual operation only

DISCOUNTS

Qty	1+	10+	25+	50+
Disc.	List	-5%	-15%	On request

Part number	Ratio	Input	Output	Max torque (Nm)	Self locking	Stock*	Price each 1 to 9
RVM25-1	1:1	hex 6mm	hex 9mm	2,0	No	✓	163,72 €
RVM25-2	2:1	hex 6mm	hex 9mm	3,0	No	✓	177,68 €
RVM25-3.25	3,25:1	hex 6mm	hex 9mm	4,0	Yes	✓	163,47 €
RVM25-4.33	4,33:1	hex 6mm	hex 9mm	5,0	Yes	✓	163,47 €
RVM25-7	7:1	hex 6mm	hex 9mm	7,0	Yes	✓	165,47 €
RVM25-8.5	8,5:1	hex 6mm	hex 9mm	9,0	Yes	✓	175,73 €
RVM25-17	17:1	hex 6mm	hex 9mm	12,0	Yes	✓	203,42 €
RVM25-20	20:1	hex 6mm	hex 9mm	15,0	Yes	✓	166,59 €
RVM25-30	30:1	hex 6mm	hex 9mm	17,0	Yes	✓	169,42 €

*Depending on availability - Dimensions in mm

Hexagonal shaft **DIN176**

Stock

AHEX For manually operated manual gearbox

- Hexagonal shaft for use with the RAM and RVM manual gearbox ranges
- Cut to required length
- Material:
Steel

Accessories

- RAM operated gearbox (tome 2 p.120)
- RVM operated gearbox (tome 2 p.122)

NUOVO!

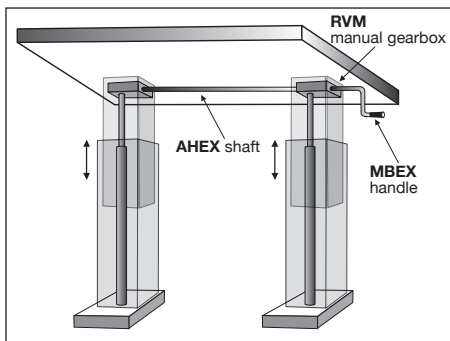
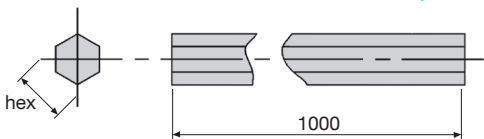
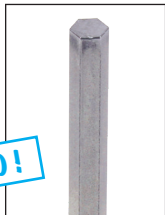

Typical application

DISCOUNTS

Qty	1+	10+	25+	50+
Disc.	List	-5%	-15%	On request

Part number	Profil	Length (mm)	Price each	
			Stock*	1 to 9
AHEX6-1000	hex 6mm	1000	✓	35,05 €
AHEX7-1000	hex 7mm	1000	✓	38,18 €
AHEX9-1000	hex 9mm	1000	✓	38,18 €

*Depending on availability - Dimensions in mm

For use with manually
operated gearbox

MBEX

- Handle for operating RAM and
RVM manual gearboxes

- Material:

Shaft: stainless steel

Rotating handle: plastic

Accessories

- RAM operated gearbox (tome 2 p.120)

- RVM operated gearbox (tome 2 p.122)



NUOVO!

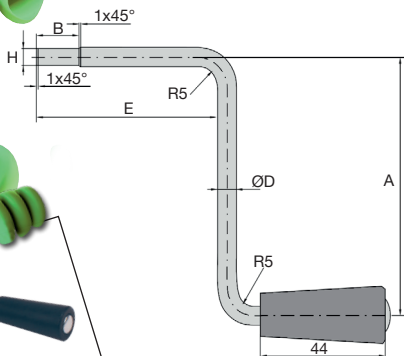
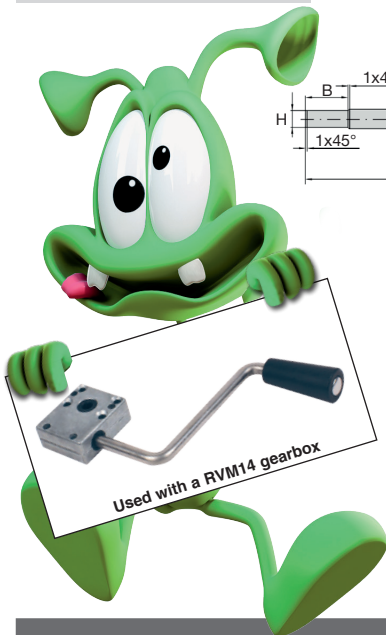

DISCOUNTS

Qty	1+	10+	25+	50+
Disc.	List	-5%	-15%	On request

Part number	A	H	ØD	E	B	Stock*	Price each
							1 to 9
MBEX6-90	90	hex 6mm	7	60	20	✓	88,21 €
MBEX7-90	90	hex 7mm	8	62	15	✓	80,17 €

*Depending on availability - Dimensions in mm