

Mini martinetto motorizzato 1A

LVT1

1 ampere

- Motore 1 Ampere da 12V a 24V CC
- Precisione assiale: $\pm 0,2$ mm
- Vite trapezoidale: inox AISI430F

Opzione

- Con sensore fine corsa magnetico (raccomandato)

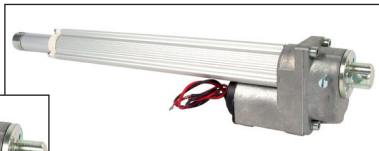
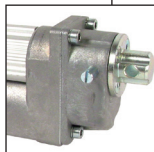

SCONTI PER QUANTITÀ

Qtà	1+	2+	4+
Sc.	Prezzo -15%		Su richiesta

Codice		Rapporto	Passo (mm)	Ø vite (mm)	Corsa (mm)	Prezzo unit.	
Senza sensore	Con sensore					Senza sensore	Con sensore
Vite trapezoidale inox passo 3 mm							
LVT1-12-3-100	LVT1-12-3-100/CFC	1/12	3	8,8	100	249,85 €	338,81 €
LVT1-12-3-150	LVT1-12-3-150/CFC	1/12	3	8,8	150	249,85 €	338,81 €
LVT1-12-3-200	LVT1-12-3-200/CFC	1/12	3	8,8	200	249,85 €	338,81 €
LVT1-12-3-250	LVT1-12-3-250/CFC	1/12	3	8,8	250	249,85 €	338,81 €
LVT1-12-3-300	LVT1-12-3-300/CFC	1/12	3	8,8	300	249,85 €	338,81 €
LVT1-48-3-100	LVT1-48-3-100/CFC	1/48	3	8,8	100	249,85 €	338,81 €
LVT1-48-3-150	LVT1-48-3-150/CFC	1/48	3	8,8	150	249,85 €	338,81 €
LVT1-48-3-200	LVT1-48-3-200/CFC	1/48	3	8,8	200	249,85 €	338,81 €
LVT1-48-3-250	LVT1-48-3-250/CFC	1/48	3	8,8	250	249,85 €	338,81 €
LVT1-48-3-300	LVT1-48-3-300/CFC	1/48	3	8,8	300	249,85 €	338,81 €
LVT1-108-3-100	LVT1-108-3-100/CFC	1/108	3	8,8	100	249,85 €	338,81 €
LVT1-108-3-150	LVT1-108-3-150/CFC	1/108	3	8,8	150	249,85 €	338,81 €
LVT1-108-3-200	LVT1-108-3-200/CFC	1/108	3	8,8	200	249,85 €	338,81 €
LVT1-108-3-250	LVT1-108-3-250/CFC	1/108	3	8,8	250	249,85 €	338,81 €
LVT1-108-3-300	LVT1-108-3-300/CFC	1/108	3	8,8	300	249,85 €	338,81 €
Vite trapezoidale inox passo 10 mm							
LVT1-12-10-100	LVT1-12-10-100/CFC	1/12	10	7,9	100	249,85 €	338,81 €
LVT1-12-10-150	LVT1-12-10-150/CFC	1/12	10	7,9	150	249,85 €	338,81 €
LVT1-12-10-200	LVT1-12-10-200/CFC	1/12	10	7,9	200	249,85 €	338,81 €
LVT1-12-10-250	LVT1-12-10-250/CFC	1/12	10	7,9	250	249,85 €	338,81 €
LVT1-12-10-300	LVT1-12-10-300/CFC	1/12	10	7,9	300	249,85 €	338,81 €
LVT1-48-10-100	LVT1-48-10-100/CFC	1/48	10	7,9	100	249,85 €	338,81 €
LVT1-48-10-150	LVT1-48-10-150/CFC	1/48	10	7,9	150	249,85 €	338,81 €
LVT1-48-10-200	LVT1-48-10-200/CFC	1/48	10	7,9	200	249,85 €	338,81 €
LVT1-48-10-250	LVT1-48-10-250/CFC	1/48	10	7,9	250	249,85 €	338,81 €
LVT1-48-10-300	LVT1-48-10-300/CFC	1/48	10	7,9	300	249,85 €	338,81 €
LVT1-108-10-100	LVT1-108-10-100/CFC	1/108	10	7,9	100	249,85 €	338,81 €
LVT1-108-10-150	LVT1-108-10-150/CFC	1/108	10	7,9	150	249,85 €	338,81 €
LVT1-108-10-200	LVT1-108-10-200/CFC	1/108	10	7,9	200	249,85 €	338,81 €
LVT1-108-10-250	LVT1-108-10-250/CFC	1/108	10	7,9	250	249,85 €	338,81 €
LVT1-108-10-300	LVT1-108-10-300/CFC	1/108	10	7,9	300	249,85 €	338,81 €

Dimensioni in mm

Tabella delle prestazioni

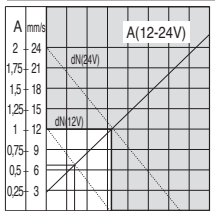

LVT1-12

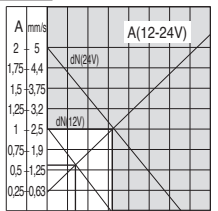

LVT1-48

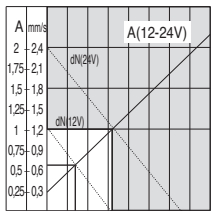

LVT1-108

1A Ciclo di funzionamento (12): 80% On 20% Off
 1A Ciclo di funzionamento (24V): 50% On 50% Off

Nota:

- Potenza ottimale ottenuta al 50% della corrente max. (vedere zona chiara del grafico)
- Utilizzo a 70° C max.
- Protettore termico su richiesta

Attenzione, queste tabelle corrispondono alle viti trapezoidali con passo 3 mm. Per il passo da 10 mm, occorre dividere i carichi per 10/3 e moltiplicare le velocità per 10/3 (lo stesso per le viti con passo 3,5 mm con fattore 3,5/3).

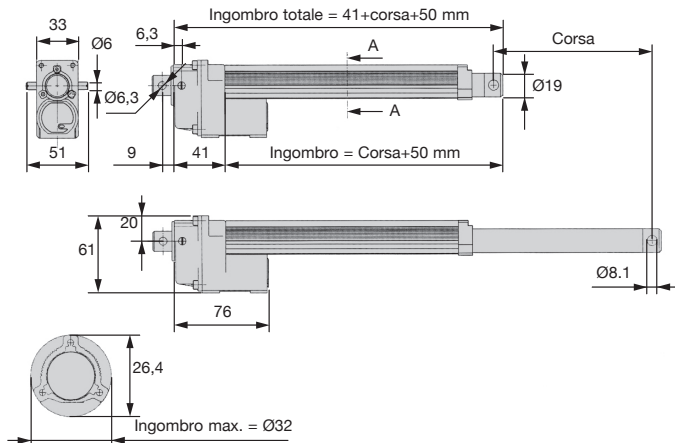

Mini martinetto motorizzato 2A

LVT2

2 ampere

- Motore 2 Ampere da 12V a 24V CC
- Precisione assiale: $\pm 0,2$ mm
- Vite trapezoidale: inox AISI430F



Opzione

- Con sensore fine corsa magnetico (raccomandato)

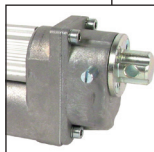

SCONTI PER QUANTITÀ

Qtà	1+	2+	4+
Sc.	Prezzo -15%	Su richiesta	

Codice		Rapporto	Passo (mm)	Ø vite (mm)	Corsa (mm)	Prezzo unit.	
Senza sensore	Con sensore					Senza sensore	Con sensore
Vite trapezoidale inox passo 3 mm							
LVT2-12-3-100	LVT2-12-3-100/CFC	1/12	3	8,8	100	249,85 €	338,81 €
LVT2-12-3-150	LVT2-12-3-150/CFC	1/12	3	8,8	150	249,85 €	338,81 €
LVT2-12-3-200	LVT2-12-3-200/CFC	1/12	3	8,8	200	249,85 €	338,81 €
LVT2-12-3-250	LVT2-12-3-250/CFC	1/12	3	8,8	250	249,85 €	338,81 €
LVT2-12-3-300	LVT2-12-3-300/CFC	1/12	3	8,8	300	249,85 €	338,81 €
LVT2-48-3-100	LVT2-48-3-100/CFC	1/48	3	8,8	100	249,85 €	338,81 €
LVT2-48-3-150	LVT2-48-3-150/CFC	1/48	3	8,8	150	249,85 €	338,81 €
LVT2-48-3-200	LVT2-48-3-200/CFC	1/48	3	8,8	200	249,85 €	338,81 €
LVT2-48-3-250	LVT2-48-3-250/CFC	1/48	3	8,8	250	249,85 €	338,81 €
LVT2-48-3-300	LVT2-48-3-300/CFC	1/48	3	8,8	300	249,85 €	338,81 €
LVT2-108-3-100	LVT2-108-3-100/CFC	1/108	3	8,8	100	249,85 €	338,81 €
LVT2-108-3-150	LVT2-108-3-150/CFC	1/108	3	8,8	150	249,85 €	338,81 €
LVT2-108-3-200	LVT2-108-3-200/CFC	1/108	3	8,8	200	249,85 €	338,81 €
LVT2-108-3-250	LVT2-108-3-250/CFC	1/108	3	8,8	250	249,85 €	338,81 €
LVT2-108-3-300	LVT2-108-3-300/CFC	1/108	3	8,8	300	249,85 €	338,81 €
Vite trapezoidale inox passo 10 mm							
LVT2-12-10-100	LVT2-12-10-100/CFC	1/12	10	7,9	100	249,85 €	338,81 €
LVT2-12-10-150	LVT2-12-10-150/CFC	1/12	10	7,9	150	249,85 €	338,81 €
LVT2-12-10-200	LVT2-12-10-200/CFC	1/12	10	7,9	200	249,85 €	338,81 €
LVT2-12-10-250	LVT2-12-10-250/CFC	1/12	10	7,9	250	249,85 €	338,81 €
LVT2-12-10-300	LVT2-12-10-300/CFC	1/12	10	7,9	300	249,85 €	338,81 €
LVT2-48-10-100	LVT2-48-10-100/CFC	1/48	10	7,9	100	249,85 €	338,81 €
LVT2-48-10-150	LVT2-48-10-150/CFC	1/48	10	7,9	150	249,85 €	338,81 €
LVT2-48-10-200	LVT2-48-10-200/CFC	1/48	10	7,9	200	249,85 €	338,81 €
LVT2-48-10-250	LVT2-48-10-250/CFC	1/48	10	7,9	250	249,85 €	338,81 €
LVT2-48-10-300	LVT2-48-10-300/CFC	1/48	10	7,9	300	249,85 €	338,81 €
LVT2-108-10-100	LVT2-108-10-100/CFC	1/108	10	7,9	100	249,85 €	338,81 €
LVT2-108-10-150	LVT2-108-10-150/CFC	1/108	10	7,9	150	249,85 €	338,81 €
LVT2-108-10-200	LVT2-108-10-200/CFC	1/108	10	7,9	200	249,85 €	338,81 €
LVT2-108-10-250	LVT2-108-10-250/CFC	1/108	10	7,9	250	249,85 €	338,81 €
LVT2-108-10-300	LVT2-108-10-300/CFC	1/108	10	7,9	300	249,85 €	338,81 €

Dimensioni in mm

Tabella delle prestazioni

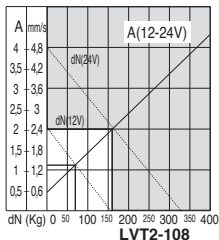
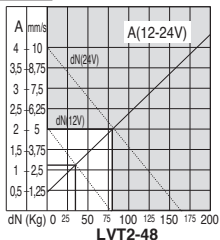
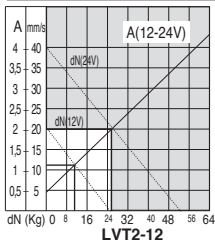

2A Ciclo di funzionamento (12): 50% On 50% Off
 2A Ciclo di funzionamento (24V): 20% On 80% Off

Nota:

- Potenza ottimale ottenuta al 50% della corrente max. (vedere zona chiara del grafico)
- Utilizzo a 70° C max.
- Protettore termico su richiesta

Attenzione, queste tabelle corrispondono alle viti trapezoidali con passo 3 mm. Per il passo da 10 mm, occorre dividere i carichi per 10/3 e moltiplicare le velocità per 10/3 (lo stesso per le viti con passo 3,5 mm con fattore 3,5/3).

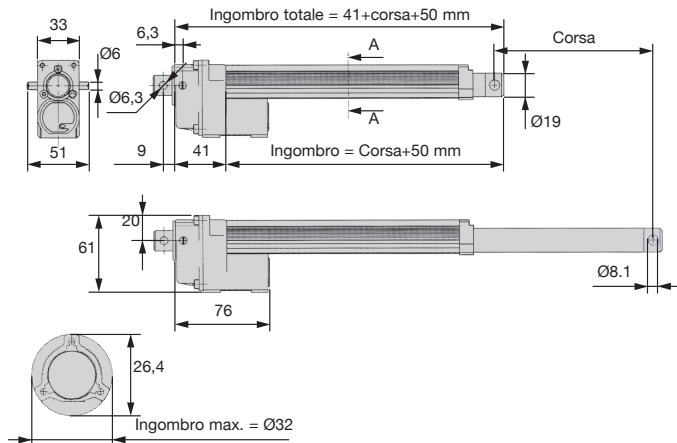

Mini martinetto motorizzato 4A

LVT4

4 ampere

- Motore 4 Ampere 12V CC
- Precisione assiale: $\pm 0,2$ mm
- Vite trapezoidale: inox AISI430F

Opzione

- Con sensore fine corsa magnetico (raccomandato)

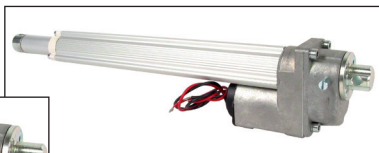
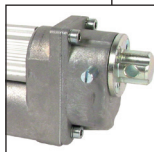

SCONTI PER QUANTITÀ

Qtà	1+	2+	4+
Sc.	Prezzo -15%	Su richiesta	Su richiesta

Codice		Rapporto	Passo (mm)	Ø vite (mm)	Corsa (mm)	Prezzo unit.	
Senza sensore	Con sensore					Senza sensore	Con sensore
Vite trapezoidale inox passo 3 mm							
LVT4-12-3-100	LVT4-12-3-100/CFC	1/12	3	8,8	100	249,85 €	338,81 €
LVT4-12-3-150	LVT4-12-3-150/CFC	1/12	3	8,8	150	249,85 €	338,81 €
LVT4-12-3-200	LVT4-12-3-200/CFC	1/12	3	8,8	200	249,85 €	338,81 €
LVT4-12-3-250	LVT4-12-3-250/CFC	1/12	3	8,8	250	249,85 €	338,81 €
LVT4-12-3-300	LVT4-12-3-300/CFC	1/12	3	8,8	300	249,85 €	338,81 €
LVT4-48-3-100	LVT4-48-3-100/CFC	1/48	3	8,8	100	249,85 €	338,81 €
LVT4-48-3-150	LVT4-48-3-150/CFC	1/48	3	8,8	150	249,85 €	338,81 €
LVT4-48-3-200	LVT4-48-3-200/CFC	1/48	3	8,8	200	249,85 €	338,81 €
LVT4-48-3-250	LVT4-48-3-250/CFC	1/48	3	8,8	250	249,85 €	338,81 €
LVT4-48-3-300	LVT4-48-3-300/CFC	1/48	3	8,8	300	249,85 €	338,81 €
LVT4-108-3-100	LVT4-108-3-100/CFC	1/108	3	8,8	100	249,85 €	338,81 €
LVT4-108-3-150	LVT4-108-3-150/CFC	1/108	3	8,8	150	249,85 €	338,81 €
LVT4-108-3-200	LVT4-108-3-200/CFC	1/108	3	8,8	200	249,85 €	338,81 €
LVT4-108-3-250	LVT4-108-3-250/CFC	1/108	3	8,8	250	249,85 €	338,81 €
LVT4-108-3-300	LVT4-108-3-300/CFC	1/108	3	8,8	300	249,85 €	338,81 €
Vite trapezoidale inox passo 10 mm							
LVT4-12-10-100	LVT4-12-10-100/CFC	1/12	10	7,9	100	249,85 €	338,81 €
LVT4-12-10-150	LVT4-12-10-150/CFC	1/12	10	7,9	150	249,85 €	338,81 €
LVT4-12-10-200	LVT4-12-10-200/CFC	1/12	10	7,9	200	249,85 €	338,81 €
LVT4-12-10-250	LVT4-12-10-250/CFC	1/12	10	7,9	250	249,85 €	338,81 €
LVT4-12-10-300	LVT4-12-10-300/CFC	1/12	10	7,9	300	249,85 €	338,81 €
LVT4-48-10-100	LVT4-48-10-100/CFC	1/48	10	7,9	100	249,85 €	338,81 €
LVT4-48-10-150	LVT4-48-10-150/CFC	1/48	10	7,9	150	249,85 €	338,81 €
LVT4-48-10-200	LVT4-48-10-200/CFC	1/48	10	7,9	200	249,85 €	338,81 €
LVT4-48-10-250	LVT4-48-10-250/CFC	1/48	10	7,9	250	249,85 €	338,81 €
LVT4-48-10-300	LVT4-48-10-300/CFC	1/48	10	7,9	300	249,85 €	338,81 €
LVT4-108-10-100	LVT4-108-10-100/CFC	1/108	10	7,9	100	249,85 €	338,81 €
LVT4-108-10-150	LVT4-108-10-150/CFC	1/108	10	7,9	150	249,85 €	338,81 €
LVT4-108-10-200	LVT4-108-10-200/CFC	1/108	10	7,9	200	249,85 €	338,81 €
LVT4-108-10-250	LVT4-108-10-250/CFC	1/108	10	7,9	250	249,85 €	338,81 €
LVT4-108-10-300	LVT4-108-10-300/CFC	1/108	10	7,9	300	249,85 €	338,81 €

Dimensioni in mm

Tabella delle prestazioni

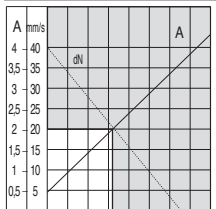

LVT4-12

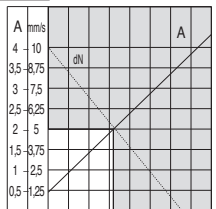

LVT4-48

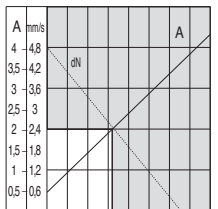

LVT4-108

4A Ciclo di funzionamento (12): 20% On 80% Off

Importante: motore fornito solo a 12 Vc.c.

Nota:

- Potenza ottimale ottenuta al 50% della corrente max. (vedere zona chiara del grafico)
- Utilizzo a 70° C max.
- Protettore termico su richiesta

Attenzione, queste tabelle corrispondono alle viti trapezoidali con passo 3 mm. Per il passo da 10 mm, occorre dividere i carichi per 10/3 e moltiplicare le velocità per 10/3 (lo stesso per le viti con passo 3,5 mm con fattore 3,5/3).

